



unicorn[®]

THE BIG NAME IN DARTS[®]

BOOK OF DARTS
2014
39TH EDITION

UNICORN-DARTS.COM

7 REASONS WHY UNICORN?

This Unicorn Book of Darts is designed to assist our trade customers around the World with their purchasing decisions.

You should stock Unicorn because:

1 UNDISPUTED	Unicorn design and engineering has powered more dart players to more World Titles than any other brand.
2 NEW PRODUCT INNOVATION	Unicorn lead and have led for over 75 years.
3 INVESTING	The PDC Unicorn Challenge Tour, The PDC Unicorn Youth Tour, The PDC Unicorn Youth World Championships creating aspirational opportunities for tomorrow's stars
4 CHOICE OF THE PDC	For 20 years until at least 2017 every dart thrown live on SKY TV uses Unicorn Eclipse Pro & Eclipse HD dartboards.
5 ON AIR	The Unicorn brand is exposed globally on TV for more than 5,000 hours each year, more than any other brand.
6 RECOGNITION	Unicorn spend more money on Brand Promotion than all other companies put together.
7 NAME	Since 1937, Unicorn – The Big Name In Darts.

These 7 reasons generate more demand for more profitable sales for the Unicorn brand from your customers than for any other dart brand.
IF YOU DON'T STOCK UNICORN, YOU ARE NOT IN THE DARTS BUSINESS.

THE UNICORN DART RANGE AT A GLANCE

PLAYER THE ACTUAL PATTERNS TEAM UNICORN USE	HALLMARK AFFORDABLE EXCELLENCE	U-TECH CUTTING EDGE TECHNOLOGY. PERFORMANCE ENHANCING	VALUE PRECISION ENGINEERED. NO NONSENSE VALUE
STEEL TIP P4-13 SOFT TIP P32-35 EVOLUTION OF THE POWER 97/95/90% Tungsten WORLD CHAMPION 90% Tungsten MAESTRO PREMIER 97/90% Tungsten MAESTRO 90% Tungsten CONTENDER 90% Tungsten LEGEND 90% Tungsten GENERATION 180 90% Tungsten GLOBAL 90% Tungsten	STEEL TIP P14-17 SOFT TIP P36-37 SILVER STAR 80% Tungsten BLACK STAR 80% Tungsten BULLET Stainless Steel BLACK Brass BARNEY Brass GOLD MEDAL Brass	STEEL TIP P18-27 SOFT TIP P38-39 SIGMA Carbon, 95/90% Tungsten LUMINA 90% Tungsten MACHINA 90% Tungsten GRIPPER 90% Tungsten MOGUL 80% Tungsten CATALYST 80% Tungsten ACADEMY 80% Tungsten SPARKS 80% Tungsten AUTOGRAPH 80% Tungsten SILVER COMET Brass  MANTIS & B-FLY Soft tip only, 90% Tungsten CC405 Brass	STEEL TIP P26-31 SOFT TIP P40-41 CORE XL 95/90/80% Tungsten MIDAS Tungsten CORE PLUS Tungsten/Brass CORE Tungsten/Brass MASS MERCHANT RANGE

WORLD CHAMPION

Raymond van Barneveld	5 Times World Champion
Anastasia Dobromyslova	3 Times World Champion
John Lowe	3 Times World Champion
Bob Anderson	World Champion

TEAM UNICORN THE PYRAMID OF EXCELLENCE

MAESTRO PREMIER

James Wade	Ranked	6
Wez Newton	Ranked	8
Andy Hamilton	Ranked	11
Gary Anderson	Ranked	18
Terry Jenkins	Ranked	19
Kevin Painter	Ranked	20

MAESTRO

Paul Nicholson	Ranked	21
----------------	--------	----

CONTENDER

Jamie Caven	Ranked	22	
Michael Smith	Ranked	30	World Youth Champion
Joe Cullen	Ranked	37	
Arron Monk	Ranked	39	World Youth Champion
Devon Petersen	Ranked	67	
Keegan Brown	Ranked	102	

GENERATION 180

Harry Annals	Petersfield Academy
Sean White	Andover Academy
Gary Thorne	Andover Academy
Dan Read	Andover Academy
Samantha Pike	Andover Academy
Jack Warner	Anderson Approved
Jack Murriner	Petersfield Academy
Gavin Howard	Andover Academy

GLOBAL

Barry Jouannet	Australia
Irina Armstrong	Russia
Steffi Lück	Germany
Tomonori Takeda	Japan
Tricia Wright	England
Michael Rosenauer	Germany
Nándor Bezzeg	Hungary
Krzysztof Kciuk	Poland



ECLIPSE PRO & ECLIPSE HD DARTBOARDS
PDC WORLD RANKED No1

World rankings taken from the PDC Order of Merit, Jan 2014.
All player action shots in this Book of Darts are courtesy
of the PDC whose co-operation we acknowledge with thanks.

Team Unicorn product development is a continuous process.
The barrels illustrated are those in use by our players at
the time of preparation of this Book of Darts.

PHASE 1
PURIST®
90% TUNGSTEN

- › Purist = Barrels Only
- › As used on TV 1996 to 1999
- › Guaranteed Weight Certified $\pm 0.1g$
- › Purist wallet
- › Engraved Unicorn Hallmark

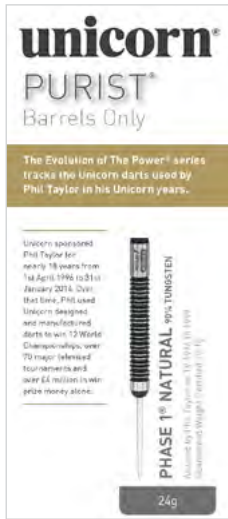

PHASE 2
PURIST®
90% TUNGSTEN

- › Purist = Barrels Only
- › As used on TV 1999 to 2007
- › Guaranteed Weight Certified $\pm 0.1g$
- › Purist wallet
- › Engraved Unicorn Hallmark

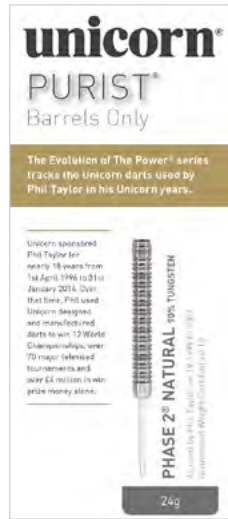

PHASE 3
PURIST® CURVE
90% TUNGSTEN

- › Purist = Barrels Only
- › As used on TV 2003
- › Guaranteed Weight Certified $\pm 0.1g$
- › Purist wallet
- › Engraved Unicorn Hallmark

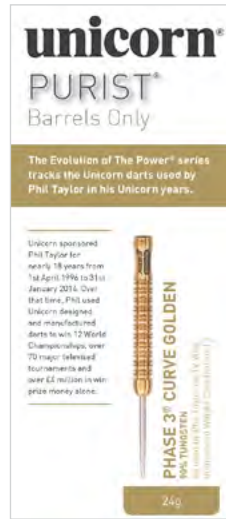

PHASE 5
PURIST®
95% TUNGSTEN

- › Purist = Barrels Only
- › As used on TV since 2008
- › Guaranteed Weight Certified $\pm 0.1g$
- › Purist wallet
- › Engraved Unicorn Hallmark

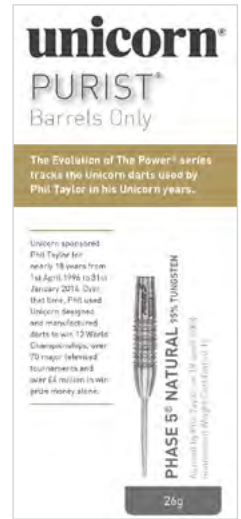

Approximate PDC Major
Tournament winnings
over £900,000



BLACK

GOLDEN

NATURAL

27042 24g 27041 24g 27040 24g



GOLDEN

NATURAL

27046 24g 27045 24g



GOLDEN

NATURAL

27050 24g 27049 24g



NATURAL

BLACK

27054 26g 27055 26g

Extra grip to back of barrel Thumb detent

In the modern era



Unicorn sponsored Phil Taylor for nearly 18 years from 1st April 1996 to 31st January 2014. Over that time, Phil used Unicorn designed and manufactured darts to win 12 World Championships, over 70 major televised tournaments and over £4 million in win prize money alone.

PHASE 5 LP
PURIST®
95% TUNGSTEN

- › Purist = Barrels Only
- › As used on TV 2013
- › Guaranteed Weight Certified ±0.1g
- › Purist wallet
- › Engraved Unicorn Hallmark

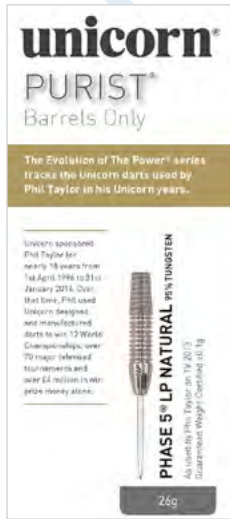

PHASE 6
PURIST®
97% TUNGSTEN

- › Purist = Barrels Only
- › As used on TV 2011
- › Guaranteed Weight Certified ±0.1g
- › Purist wallet
- › Engraved Unicorn Hallmark

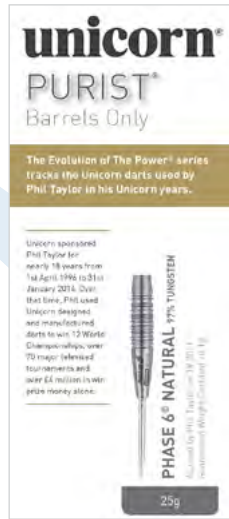

EVOLUTION OF THE POWER®

Tracks the Unicorn darts used by Phil Taylor in his Unicorn years.

STEEL TIP

PHASE 5 95% TUNGSTEN

- › As used on TV since 2008
- › Phase 5 Titanium side load shafts with replaceable tops
- › Guaranteed Weight Certified ±0.1g
- › Premium Phase 5 wallet
- › Engraved Unicorn Hallmark

All Phase 5 darts are supplied complete with an additional set of DXM flights

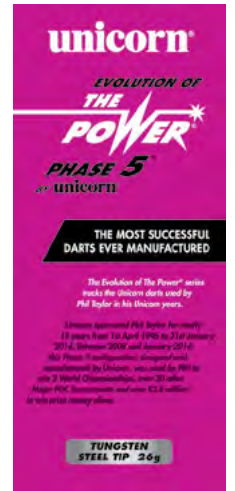

Approximate PDC Major Tournament winnings over £2.8m



NATURAL

27058 26g



NATURAL

27061 25g



BLACK

27062 25g



ROSSO

27068 26g



NATURAL

27066 26g



BLACK

27067 26g



GOLDEN

27065 26g

Always working to improve

The most successful darts ever manufactured

➤ Physical Vapour Deposition (PVD) finish on Black, Golden & Rosso for non-slip grip.

WORLD CHAMPION BLACK TITANIUM 90% TUNGSTEN

- › Barrel designs as used by World Champions on TV
- › Black Titanium PVD non-slip grip
- › XL Ti 100% Black Titanium shafts
- › Guaranteed Weight Certified $\pm 0.1g$
- › Premium wallet
- › Engraved Unicorn Hallmark

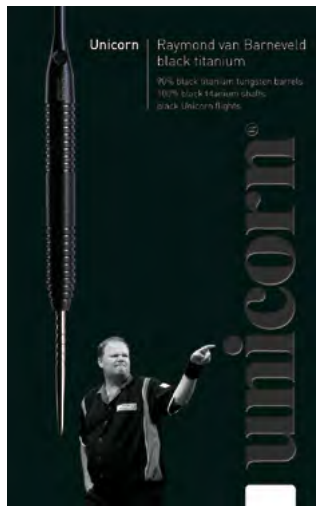

weight illustrated LP Finish

RAYMOND van BARNEVELD

5 times world champion

10323 23g

10324 25g Used by Raymond van Barneveld

WORLD CHAMPION GOLDEN TITANIUM 90% TUNGSTEN

- › Barrel designs as used by World Champions on TV
- › Golden Titanium PVD non-slip grip
- › Anodised aluminium shafts
- › Guaranteed Weight Certified $\pm 0.1g$
- › Premium wallet
- › Engraved Unicorn Hallmark



weight illustrated LP Finish

RAYMOND van BARNEVELD

5 times world champion

10137 23g

10138 25g Used by Raymond van Barneveld

weight illustrated

JOHN LOWE

3 times world champion

10156

21g Used by John Lowe

weight illustrated

ANASTASIA DOBROM LOVA

3 times world champion

10152 22g

Used by Anastasia Dobromyslova

10153 24g

10154 26g



- › Barrel designs as used by World Champions on TV
- › Natural Tungsten
- › World Champion Aluminium shafts
- › Guaranteed Weight Certified $\pm 0.1g$
- › Premium wallet
- › Engraved Unicorn Hallmark



RAYMOND van BARNEVELD
5 times world champion



NEW

<p>weight illustrated</p> <p>LP Finish</p> <p>PHASE 1</p> <p>10184 21g 10185 23g 10186 25g Used by Raymond van Barneveld 10187 27g</p>	<p>LP Finish</p> <p>PHASE 2</p> <p>10368 25g Phase 2 Used by Raymond van Barneveld</p>	<p>LP Finish</p> <p>PHASE 2A natural/golden hybrid</p> <p>10369 25g Phase 2A Hybrid Used by Raymond van Barneveld</p>	<p>sawtooth grip</p> <p>PHASE 3</p> <p>10382 25g Phase 3 Used by Raymond van Barneveld</p>	<p>weight illustrated</p> <p>LP Finish</p> <p>PHASE 4</p> <p>11035 23g Phase 4 Used by Raymond van Barneveld 11036 25g</p>	<p>weight illustrated</p> <p>ANASTASIA DOBROMYSLOVA 3 times world champion</p> <p>10190 22g Used by Anastasia Dobromyslova 10191 24g 10192 26g</p>	<p>weight illustrated</p> <p>JOHN LOWE 3 times world champion</p> <p>10162 21g Used by John Lowe 10163 23g 10164 25g 10165 27g</p>	<p>weight illustrated</p> <p>BOB ANDERSON world champion</p> <p>10179 20g Used by Bob Anderson 10180 22g 10181 24g</p>
--	---	--	---	--	---	--	---

MAESTRO® PREMIER PLAYERS CHOICE
97%/90% TUNGSTEN

UNICORN PDC PREMIER LEAGUE PLAYERS

- › Barrel designs as used by Maestro Premiers on TV
- › Black or Golden Titanium PVD non-slip grip finishes as used by players
- › Aluminium shafts
- › Guaranteed Weight Certified $\pm 0.1g$
- › Premium wallet
- › Engraved Unicorn Hallmark



weight illustrated

ANDY HAMILTON

11009 23g
11010 25g
Used by Andy Hamilton
(Both 97% Tungsten)



WEZ NEWTON

11023 22g
Used by Wez Newton



weight illustrated

GARY ANDERSON

10128 22g
10129 24g
Used by Gary Anderson
10130 26g



weight illustrated

JAMES WADE

10117 20g
Used by James Wade
10118 22g
10119 24g



TEAM UNICORN
PDC PREMIER LEAGUE PLAYERS

UNICORN. THE BIG NAME IN DARTS.

UNICORN PDC PREMIER LEAGUE PLAYERS

- › Barrel designs as used by Maestro Premiers on TV
- › Natural Tungsten
- › Maestro Aluminium shafts
- › Guaranteed Weight Certified $\pm 0.1g$
- › Premium wallet
- › Engraved Unicorn Hallmark



weight illustrated

WEZ NEWTON

11026 22g
Used by
Wez Newton
11027 24g



weight illustrated

GARY ANDERSON PHASE 1

10392 22g
10393 24g
Used by
Gary Anderson
10394 26g



weight illustrated

GARY ANDERSON PHASE 2

10395 22g
10397 24g
Used by
Gary Anderson



weight illustrated

Gripper Finish

JAMES WADE PHASE 1

10266 20g
Used by
James Wade
10267 22g
10268 24g



weight illustrated

Gripper Finish

JAMES WADE PHASE 2

11030 20g
Used by
James Wade
11031 22g
11032 24g



weight illustrated

ANDY HAMILTON

10385 23g
10386 25g
Used by
Andy Hamilton
10387 27g
(All 97% Tungsten)



weight illustrated

KEVIN PAINTER

11019 20g
Used by
Kevin Painter
11020 22g
11021 24g



weight illustrated

TERRY JENKINS

10272 21g
Used by
Terry Jenkins
10273 23g
10274 25g

NEW

NEW

MAESTRO® PLAYERS CHOICE 90% TUNGSTEN

- › Barrel designs as used by Maestros on TV
- › Black or Golden Titanium PVD non-slip grip finishes as used by players
- › Maestro II Aluminium shafts
- › Guaranteed Weight Certified $\pm 0.1g$
- › Compact case
- › Engraved Unicorn Hallmark



PAUL NICHOLSON



MAESTRO® NATURAL 90% TUNGSTEN

- › Barrel designs as used by Maestros on TV
- › Natural Tungsten
- › Maestro Aluminium shafts
- › Guaranteed Weight Certified $\pm 0.1g$
- › Compact case
- › Engraved Unicorn Hallmark



PAUL NICHOLSON



10647 20g

weight illustrated

10649 20g
Used by Paul Nicholson
10650 22g
10651 24g



Unicorn is delighted to work with the leading referees in the World.

RUSS "The Voice" BRAY
ENGLAND



GORDON SHUMWAY
GERMANY

UNICORN. THE BIG NAME IN DARTS.

CONTENDER 90% TUNGSTEN

RISING STARS IN THE PDC RANKINGS

- › Barrel designs as used by Contenders on TV
- › Gripper shafts
- › Guaranteed Weight Certified $\pm 0.1g$
- › Compact case
- › Engraved Unicorn Hallmark



NEW



DEVON PETERSEN

NEW



MICHAEL SMITH



ARRON MONK

NEW



JAMIE CAVEN



JOE CULLEN



KEEGAN BROWN

10373 22g

10326 22g

10388 22g

10330 23g

10305 22g

10309 22g

weight illustrated



BARRY TWOMLOW

10768 22g

10769 24g

PLAYER

THE ACTUAL PATTERNS TEAM UNICORN USE

STEEL TIP

LEGEND

90% TUNGSTEN

- › 90% Tungsten Nickel Alloy
- › Guaranteed Weight Certified $\pm 0.1g$
- › Compact case
- › Engraved Unicorn Hallmark



Barry Twomlow

News Of The World Champion
"The Man Who Taught
The World To Play Darts"



GENERATION 180

97%/95%/90% TUNGSTEN

WORLD CHAMPIONS OF TOMORROW

Younger players rising through the ranks from Unicorn's partnership with Dart Academies



- › Reinvesting in Youth Darts by sponsoring the PDC Unicorn Youth Tour & PDC Unicorn World Youth Championships through to 2017
- › Promoting today for tomorrow's sales
- › Gripper shafts
- › Guaranteed Weight Certified $\pm 0.1g$
- › Compact case
- › Engraved Unicorn Hallmark

GAVIN HOWARD

JACK MARRINER

JACK WARNER

GARY THORNE

SAMANTHA PIKE

HARRY ANNALS

DAN READ

SEAN WHITE

07551 24g

07538 24g

07523 25g

07528 25g
(95% Tungsten)

07541 29g

07536 23g
(97% Tungsten)

07530 26g

07504 22g



Unicorn is proud to be a partner of the Andover Academy, Petersfield Academy, Steve Brown Darts Academy, Ashford Academy and Jamie Caven Darts Academy.



LOCAL HEROES DRAWN FROM UNICORN'S
GLOBAL PROMOTION NETWORK

- › Reflecting Unicorn's International reach and Global consumer demand
- › Gripper shafts
- › Guaranteed Weight Certified $\pm 0.1g$
- › Compact case
- › Engraved Unicorn Hallmark



STEFFI LÜCK

10662 23g

NEW



10670 20g

KRZYSZTOF KCIUK



10758 29g

TRICIA WRIGHT



10396 23g

NANDOR BEZEG



10366 23g
Irina uses
Black Titanium

IRINA ARMSTRONG

NEW



10735 22g

MICHAEL ROSENAUER



10752 20g

TOMONORI TAKEDA



10729 23g

BARRY JOUANNET



SILVER STAR™ 80% TUNGSTEN

- › Natural Tungsten
- › Gripper shafts
- › Compact case
- › Engraved Unicorn Hallmark



NEW



weight illustrated

THE POWER®

- 27206 22g
- 27207 24g
- 27208 26g
- 27209 28g
- 27210 30g



NEW



weight illustrated

RAYMOND van BARNEVELD

- 07416 22g
- 07417 24g
- 07418 26g
- 07419 28g



weight illustrated

GARY ANDERSON

- 08558 21g
- 08559 23g
- 08560 25g

NEW



weight illustrated

JAMES WADE

- 08563 22g
- 08564 24g



weight illustrated

RAYMOND van BARNEVELD

- 07196 24g
- 07197 26g



NEW



weight illustrated

THE POWER®

- 27213 22g
- 27214 24g
- 27215 26g



BLACK STAR 80% TUNGSTEN

- › Black Titanium PVD non-slip grip
- › Gripper shafts
- › Compact case
- › Engraved Unicorn Hallmark



BULLET®
STAINLESS STEEL

STYLE MEETS VALUE

- › Super Durable Stainless Steel
- › XL Aluminium shafts
- › Compact case
- › Engraved Unicorn Hallmark



weight illustrated

JOHN LOWE

- 07291 21g
- 07292 23g
- 07293 25g



weight illustrated

RAYMOND van BARNEVELD

- 07547 21g
- 07548 23g
- 07549 25g



weight illustrated

THE POWER®

- 27200 22g
- 27201 24g
- 27202 26g

NEW

HALLMARK
AFFORDABLE EXCELLENCE

STEEL TIP

BLACK BRASS

- › Matt Black brass barrels
- › XL shafts
- › Compact case
- › Engraved Unicorn Hallmark



weight illustrated

RAYMOND van BARNEVELD

- 07715 22g
- 07716 24g
- 07717 26g



weight illustrated

THE POWER®

- 27218 23g
- 27219 25g
- 27220 27g

NEW

BARNEY BRASS

5 TIMES WORLD CHAMPION

RAYMOND van BARNEVELD ENDORSED

- › Colour coordinated
- › 100% brass barrels
- › Gripper shafts
- › Compact case



weight illustrated



RAYMOND van BARNEVELD

weight illustrated



weight illustrated



weight illustrated



07805 21g
07806 23g
07807 25g
07808 27g

07811 21g
07812 23g
07813 25g
07814 27g

07817 21g
07818 23g
07819 25g
07820 27g

07823 21g
07824 23g
07825 25g

GOLD MEDAL BRASS

- > 100% brass barrels
- > Gripper shafts
- > Compact case
- > Comprehensive weight and pattern range

HALLMARK AFFORDABLE EXCELLENCE

STEEL TIP



27161 30g



27160 29g



27158 28g



27157 27g



27156 26g



27154 25g



27140 24g



27134 23g



27129 22g



27108 21g



27107 20g



27104 19g

SIGMA™ SUPER PRO CARBON 95% TUNGSTEN

TUNED FOR BEST ACCURACY.

- › Sigma certified use of Carbon Fibre material for compelling strength:weight ratio
- › Screw In Sigma ZeroD Carbon Nose Cones: 3 x 25mm & 3 x 25mm finger grip
- › Sigma Super Pro 100% Carbon Fibre shafts
- › Sigma Super Pro ultra compact delta flights
- › Sigma Carbon Premium Wallet



weight illustrated

10665 21g
10666 23g
10667 25g

SIGMA™ XL SUPER PRO 95% TUNGSTEN

TUNED FOR BEST ACCURACY

- › Unforgiving performance, recommended for a player at the peak of his game
- › Screw In Titanium Zero Deflection Nose Cones: 3 x 25mm & 3 x 25mm finger grip
- › Sigma Super Pro 100% Magnesium shafts
- › Sigma Super Pro ultra compact delta flights
- › Sigma Premium wallet



weight illustrated

10363 21g
10364 23g
10365 25g

SIGMA™ XL PRO 95% TUNGSTEN

TUNED FOR BETTER ACCURACY

- › Screw In Titanium Zero Deflection Nose Cones: 3 x 28mm & 3 x 28mm finger grip
- › Sigma Pro Magnesium side-load shafts
- › Sigma Pro compact delta flights
- › Sigma Premium wallet



weight illustrated

10375 21g
10376 23g
10377 25g



See more about Sigma at
www.unicorn-darts.com/range/darts-sigma.aspx

SIGMA™ X CROSS TIP
 95% TUNGSTEN
 TUNED FOR ACCURACY

- › Sigma Super Pro Carbon shafts
- › Set of black Teknik tips x 6
- › Sigma One white flights
- › Set of 3 Sigma ZeroD CR Nosecones - 28mm
- › Sigma wallet
- › Assembled as steel tip in the case

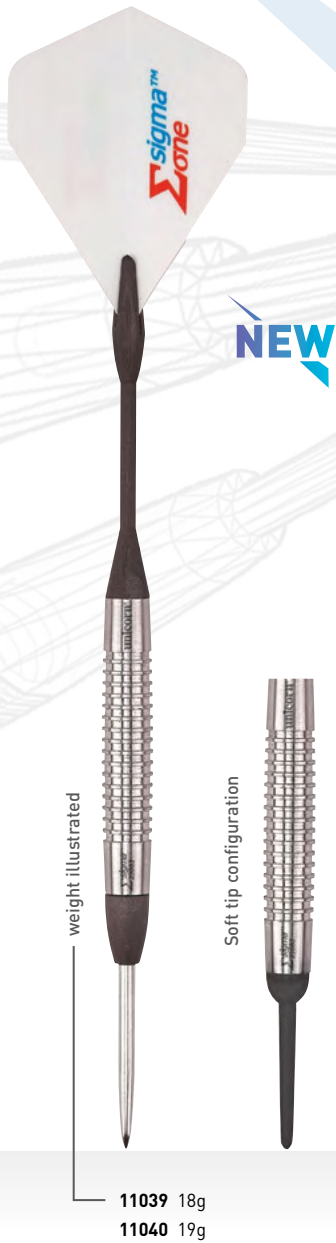

SIGMA™ X CROSS TIP
 CHAMPIONSHIP
 95% TUNGSTEN
 TUNED FOR ACCURACY

- › Sigma CR shafts
- › Set of black Teknik tips x 6
- › Sigma One black flights
- › Set of 3 Sigma ZeroD Titanium Nosecones - 28mm
- › Sigma wallet
- › Assembled as steel tip in the case



SIGMA™ PRO 970
 97% TUNGSTEN
 TUNED FOR ACCURACY

- › Available in Natural Tungsten or Golden Titanium PVD for non-slip grip
- › Sigma Pro Titanium side-load shafts
- › Sigma Pro compact delta flights
- › Sigma Premium wallet



Sigma X Cross Tip are Sigma certified in both steel tip and soft tip configurations. In both configurations the darts weigh the same - eg 18g Sigma X - when configured as the Steel Tip pointed barrel is 18g, when configured as the Soft Tip the all up weight is 18g. This allows the Cross Code player to always use the same barrels and weight.

SIGMA™ PRO 950
95% TUNGSTEN

TUNED FOR ACCURACY.
COARSE GRIP.

- › Available in Natural Tungsten or Golden Titanium PVD for non-slip grip
- › Sigma Pro Titanium side-load shafts
- › Sigma Pro compact delta flights
- › Sigma Premium wallet



SIGMA™ 4 PRO
95% TUNGSTEN

TUNED FOR ACCURACY.
FORWARD WEIGHTED.

- › Screw In Titanium Zero Deflection Nose Cones 25mm finger grip
- › Sigma Pro Titanium side-load shafts
- › Sigma Pro compact delta flights
- › Sigma Premium wallet

SIGMA™ ONE 970
97% TUNGSTEN

TUNED FOR STABILITY

- › Sigma One rigid shafts
- › Sigma One enhanced delta flights
- › Sigma Premium wallet

SIGMA™ ONE 950
95% TUNGSTEN

TUNED FOR STABILITY.
COARSE GRIP.

- › Sigma One rigid shafts
- › Sigma One enhanced delta flights
- › Sigma Premium wallet



weight illustrated

GOLDEN

10954 22g
10955 24g



weight illustrated

NATURAL

10960 18g
10961 20g
10962 22g
10963 24g
10964 26g



weight illustrated

10398 20g
10399 22g
10400 24g

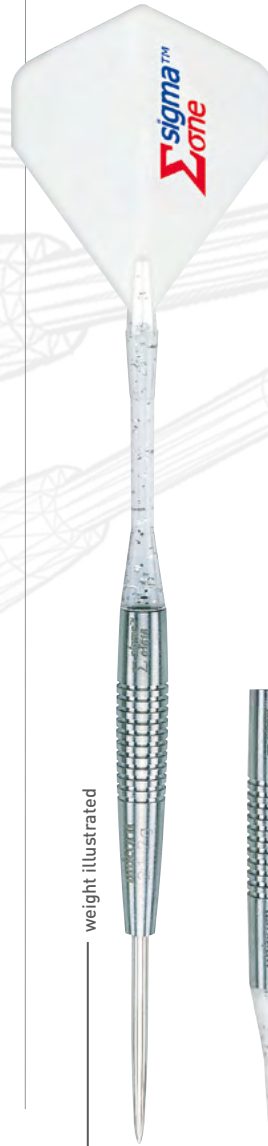

weight illustrated

10907 21g
10908 23g
10909 25g
10910 27g



03594 19g

SOFT TIP OPTIMISED FOR SOFT TIP BOARDS

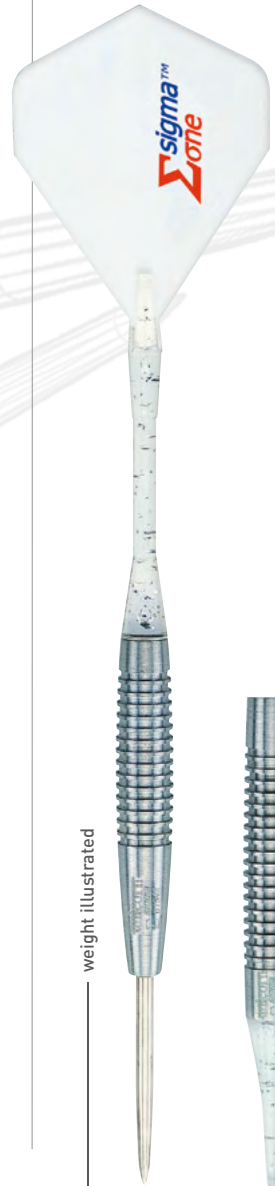

weight illustrated

10967 20g
10968 22g
10969 24g
10970 26g



03595 18g

SOFT TIP OPTIMISED FOR SOFT TIP BOARDS



All Sigma darts are designed as integrated aerodynamic units optimised for Accuracy (Pro) or Stability (One).

LUMINA™ 90% TUNGSTEN

- › Shark toothed barrel - outstanding grip
- › Aerodynamic bullet barrel profile
- › Finger grip points for total control
- › Q .100 micron fin flights
- › 90% Unicorn Certified Tungsten Nickel Alloy
- › XL Aluminium shafts



NEW

weight illustrated

05095 21g
05096 23g
05097 25g

LUMINA™ DNA 90% TUNGSTEN

- › Shark toothed barrel - outstanding grip
- › DNA titanium coating - each barrel unique
- › Finger grip points for total control
- › Q .100 micron fin flights
- › 90% Unicorn Certified Tungsten Nickel Alloy
- › XL 100% Titanium DNA shafts

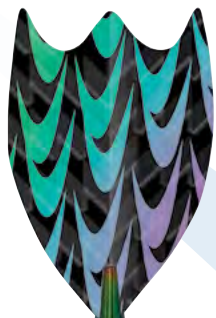

NEW

weight illustrated

05100 21g
05101 23g
05102 25g

CUTTING EDGE TECHNOLOGY. PERFORMANCE ENHANCING

STEEL TIP

MACHINA™ GOLD 90% TUNGSTEN

- › Golden Titanium PVD non-slip surface
- › Complex precision grip
- › Machina aluminium shafts
- › Maestro .100 micron pro-grade flights

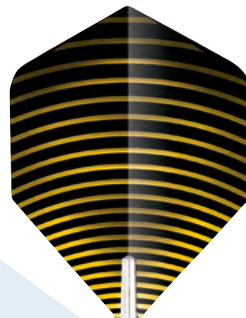

NEW

weight illustrated

05085 21g
05086 23g
05087 25g



MACHINA™ BLACK 90% TUNGSTEN

- › BlackTitanium PVD non-slip surface
- › Complex precision grip
- › Machina aluminium shafts
- › Maestro .100 micron pro-grade flights



NEW

weight illustrated

05090 22g
05091 24g
05092 26g



GRIPPER® 90% TUNGSTEN

- › Aggressive and individual barrel grips
- › Engineered finger grip points
- › Gripper 360 rotating shafts
- › Compact case
- › Engraved Unicorn Hallmark



weight illustrated

GORDON SHUMWAY

weight illustrated

weight illustrated

weight illustrated

- 05051** 22g
- 05052** 24g
- 05053** 26g

Used By Gordon Shumway

- 05027** 21g
- 05028** 23g
- 05029** 25g

- 05032** 20g
- 05033** 22g
- 05034** 24g

- 05047** 23g
- 05048** 25g

MOGUL™ TUNGSTEN



- › Innovative manufacturing process creates barrel grips that are not possible with traditional machining
- › Gripper 3 shafts
- › Core 75 micron flights
- › Compact case
- › Engraved Unicorn Hallmark



weight illustrated

Aero golf ball grip

weight illustrated

Hexagonal front grip morphs to circular rear grip.

- 07873** 22g
- 07874** 24g
- 07875** 26g

- 07878** 21g
- 07879** 23g
- 07880** 25g

CATALYST® 80% TUNGSTEN

- › Diamond cut grip
- › Catalyst shafts
- › Compact case
- › Engraved Unicorn Hallmark



weight illustrated

- 07786 21g
- 07787 23g
- 07788 25g

U-TECH

CUTTING EDGE TECHNOLOGY. PERFORMANCE ENHANCING

STEEL TIP

ACADEMY® 80% TUNGSTEN

- › Developed by working with Junior players
- › Ideal front loaded balance helps improve technique
- › Gripper shafts
- › Micro case
- › Engraved Unicorn Hallmark



weight illustrated LP Finish

- 05055 15g
- 05056 17g

SPARKS™ 80% TUNGSTEN

- › Colour coordinated total presentation
- › XL Aluminium shafts
- › Compact case
- › Engraved Unicorn Hallmark



weight illustrated

07671 22g
07672 24g
07673 26g



weight illustrated

07667 22g
07668 24g
07669 26g

AUTOGRAPH® 80% TUNGSTEN

- › Configured by and for lady players
- › Subtle total coordination
- › Gripper shafts
- › White Compact case
- › Fully coordinated accessories available

FOR REAL STYLE ON THE OCHE!



weight illustrated

05850 22g
05851 24g
05852 26g



weight illustrated

05855 23g
05856 25g
05857 27g

Autograph®
collection

NEW



HERITAGE RANGE

PRICELESS REPLICAS

The Unicorn Heritage range showcases landmark Unicorn design, products & innovation since the Company was founded by Frank Lowy in the 1930's.



Every model in the Unicorn Heritage range is a priceless replica of historic Unicorn engineering and will continue to interest, fascinate and delight collectors, connoisseurs and enthusiasts alike.



1937 SILVER COMET®

- › Plated brass barrels
- › Slotted flight holder
- › Aluminium alloy shafts
- › Patented screw shaft cap
- › Comet fibreboard flights
- › Replica presentation box

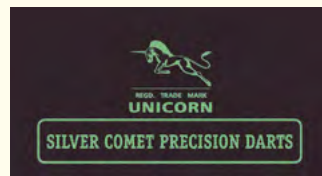

Replica presentation box

SILVER COMET PRECISION DARTS

BRITISH PATENT No. 484,292. U.S. PATENT No. 2,182,296.



Introduced in 1937, these splendid darts have been unsurpassed in construction, design and popularity ever since. Over a quarter of a million sets have been sold to date and many of the original batch are still giving perfect service, as testified by many appreciative letters received from actual users. The plated brass body is fitted with a streamlined cap screwed on the rear end of the shaft. The flight is thus perfectly encased in metal and no loss of score is possible, because if a following dart hits the streamlined cap it glances off to lodge in the board.

Reproduced from the First Edition of the Unicorn Book of Darts



07100 Medium

78608 Comet replacement shafts (dozen sets)

68502 Comet replacement flights (dozen sets)

CORE XL T95 95% TUNGSTEN

- › Very high density tungsten for super slim barrels
- › Gripper II shafts
- › Slimline case
- › Engraved Unicorn Hallmark
- › XL Bonus Pack of accessories comprising:
 - 2 sets of Gripper shafts,
 - 2 sets of polyester flights,
 - 8 flight protectors,
 - 6 spare Gripper rings,
 - 1 Checkout Chart



CORE XL T90 90% TUNGSTEN

- › Range of precision engineered barrels
- › Gripper II shafts
- › Slimline case
- › Engraved Unicorn Hallmark
- › XL Bonus Pack of accessories comprising:
 - 2 sets of Gripper shafts,
 - 2 sets of polyester flights,
 - 8 flight protectors,
 - 6 spare Gripper rings,
 - 1 Checkout Chart



CORE XL T80 80% TUNGSTEN

- › Great value enhanced Tungsten range
- › Gripper II shafts
- › Slimline case
- › Engraved Unicorn Hallmark
- › XL Bonus Pack of accessories comprising:
 - 2 sets of Gripper shafts,
 - 2 sets of polyester flights,
 - 8 flight protectors,
 - 6 spare Gripper rings,
 - 1 Checkout Chart



weight illustrated

07444 21g
07445 23g
07446 25g
07447 27g
07448 29g

weight illustrated

07397 23g
07398 25g
07399 27g
07400 29g

weight illustrated

07859 22g
07860 24g
07861 26g

weight illustrated

07378 23g
07379 25g

weight illustrated

05059 22g
05060 24g
05061 29g
05062 36g

weight illustrated

05079 21g
05080 23g
05081 25g
05082 27g



- › Slimline case
- › Ultra slim
- › Durable

CORE XL STRIKER®
80% TUNGSTEN

VALUE

PRECISION ENGINEERED. NO NONSENSE VALUE

STEEL TIP

- › Huge range of budget Tungsten dart sets
- › Gripper II shafts
- › Slimline case
- › XL Bonus Pack of accessories comprising:
2 sets of Gripper shafts, 2 sets of polyester flights,
8 flight protectors, 6 spare Gripper rings,
1 Checkout Chart



05016 29g 05017 30g 05019 32g 05021 34g 05022 36g 05023 38g 05024 40g



05016 29g 05001 18g 05002 19g 05003 20g 05004 21g 05005 22g 05006 23g 05008 24g 05011 25g 05012 26g 05014 27g 05015 28g

MIDAS™
TUNGSTEN

NEW

UNICORN BIN ENDS!

From time to time we end up with end of lines, now available for the first time through our Midas programme.

All Midas darts use 100% genuine Unicorn manufactured components made entirely in our own factories and offer incredible value for money.

Midas are available in Natural Tungsten and Titanium Tungsten, contact the Unicorn Sales Office assist@unicorngroup.com to check current availability.



CORE PLUS
TUNGSTEN

- › Precision engineered Tungsten barrels
- › Gripper II shafts
- › Compact footprint
- › Engraved Unicorn Hallmark
- › High impact shelf appeal
- › Complete with Dart Wallet



weight illustrated

- 07272 21g
- 07273 23g
- 07274 25g
- 07275 27g



CORE PLUS
BLACK

- › Coated brass barrels
- › Gripper II shafts
- › Compact footprint
- › Engraved Unicorn Hallmark
- › High impact shelf appeal
- › Complete with Dart Wallet



weight illustrated

- 07347 22g
- 07348 24g
- 07349 26g



Wallet included in all Core Plus packs



CORE PLUS BRASS

- › Precision machined brass barrels
- › Gripper II shafts
- › Compact footprint
- › High impact shelf appeal
- › Complete with Dart Wallet



weight illustrated

- 07255 22g
- 07256 24g
- 07257 26g
- 07258 28g

VALUE

PRECISION ENGINEERED. NO NONSENSE VALUE

STEEL TIP

CORE TUNGSTEN

- › Quality materials
- › Quality engineering
- › Budget price
- › Gripper shafts
- › Very compact footprint for best sales density
- › Engraved Unicorn Hallmark



weight illustrated

- 07773 21g
- 07774 23g
- 07775 25g
- 07776 27g

CORE BRASS

- › Pure quality 100% brass
- › Gripper shafts
- › Very compact footprint for best sales density



weight illustrated

- 07768 21g
- 07769 23g
- 07770 25g



71648
6 sets per master carton



71651
6 sets per master carton



71653 17g 71654 19g 71655 21g
6 sets per master carton



71657 20g 71658 22g 71659 24g
3 sets per master carton



71660 21g 71661 23g 71662 25g
3 sets per master carton



71663 21g 71664 23g 71665 25g
3 sets per master carton



71669 21g 71670 23g 71671 25g
2 sets per master carton



71678 22g 71679 24g
2 sets per master carton

MASS MERCHANT RANGE

CONTACT YOUR LOCAL UNICORN SALES OFFICE



71772 17g
3 sets per master carton

- › Concise range
- › Concentrated turnover
- › Fully sealed packs
- › Clam or blister packed
- › Only available to special order



71667 21g 71666 23g 71668 25g
2 sets per master carton



71673 24g 71674 26g
3 sets per master carton



77872
6 sets per master carton



77873
6 sets per master carton



77874
6 sets per master carton

PHASE 1
PURIST®
90% TUNGSTEN

- › Purist = Barrels Only
- › Steel Tip version used on TV 1996 to 1999
- › Purist wallet
- › Engraved Unicorn Hallmark

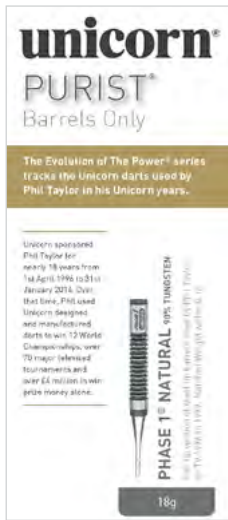

23102 18g 23101 18g

PHASE 2
PURIST®
90% TUNGSTEN

- › Purist = Barrels Only
- › Steel Tip version used on TV 1999 to 2007
- › Purist wallet
- › Engraved Unicorn Hallmark

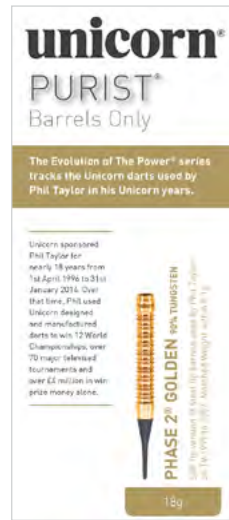

23104 18g 23105 18g

PHASE 3
PURIST® CURVE
90% TUNGSTEN

- › Purist = Barrels Only
- › Steel Tip version used on TV 2003
- › Purist wallet
- › Engraved Unicorn Hallmark

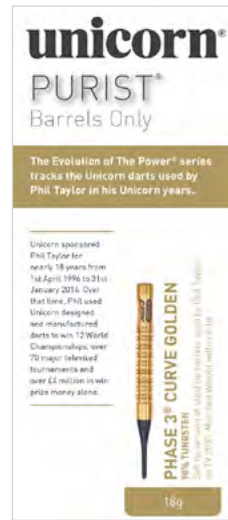

23108 18g 23109 18g

PHASE 5
PURIST®
95% TUNGSTEN

- › Purist = Barrels Only
- › Steel Tip version used on TV since 2008
- › Purist wallet
- › Engraved Unicorn Hallmark

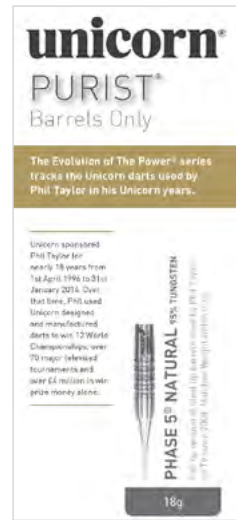

23112 18g 23113 18g

Extra grip to back of barrel Thumb detent

➤ Unicorn sponsored Phil Taylor for nearly 18 years from 1st April 1996 to 31st January 2014. Over that time, Phil used Unicorn designed and manufactured darts to win 12 World Championships, over 70 major televised tournaments and over £4 million in win prize money alone.

➤ The darts illustrated are the soft tip versions of the Evolution of The Power Steel Tip series.

PHASE 5 LP
PURIST®
95% TUNGSTEN

- › Purist = Barrels Only
- › Steel Tip version used on TV 2013
- › Purist wallet
- › Engraved Unicorn Hallmark

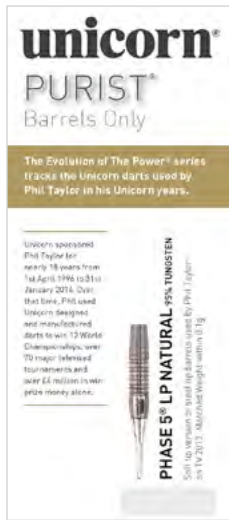

NATURAL

- 23117 18g
- 23118 20g
- 23119 22g

PHASE 6
PURIST®
97% TUNGSTEN

- › Purist = Barrels Only
- › Steel Tip version used on TV 2011
- › Purist wallet
- › Engraved Unicorn Hallmark

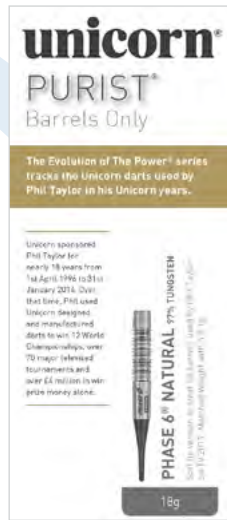

NATURAL

23122 18g



BLACK

23123 18g

EVOLUTION OF THE POWER®

Tracks the Unicorn darts used by Phil Taylor in his Unicorn years.

SOFT TIP

PHASE 5 95% TUNGSTEN

- › Steel Tip version used on TV since 2008
- › Phase 5 Titanium side load shafts with replaceable tops
- › Premium Phase 5 Midi wallet
- › Engraved Unicorn Hallmark



All Phase 5 darts are supplied complete with an additional set of DXM flights



ROSSO

23129 18g



NATURAL

23127 18g



BLACK

23128 18g



GOLDEN

23126 18g

➤ Physical Vapour Deposition (PVD) finish on Black, Golden & Rosso for non-slip grip.

WORLD CHAMPION NATURAL 90% TUNGSTEN

- › Barrel designs as used by World Champions
- › Natural Tungsten
- › Anodised Aluminium shafts
- › Premium wallet
- › Engraved Unicorn Hallmark



ANASTASIA DOBROMYSLOVA
3 times world champion

04042 18g



JOHN LOWE 3 times world champion

04046 18g



BOB ANDERSON world champion

04054 19g



RAYMOND van BARNEVELD
5 times world champion

04037 17g
04038 19g



RAYMOND van BARNEVELD Phase 2

04121 19g



RAYMOND van BARNEVELD Phase 3

04141 18g

MAESTRO® PREMIER TITANIUM 90% TUNGSTEN

UNICORN PDC PREMIER LEAGUE PLAYERS

- › Barrel designs as used by Maestro Premiers
- › Black PVD non-slip grip
- › Aluminium shafts
- › Premium wallet
- › Engraved Unicorn Hallmark



GARY ANDERSON

04061 18g



JAMES WADE

03593 18g

PLAYER

THE ACTUAL PATTERNS TEAM UNICORN USE

SOFT TIP

MAESTRO® PREMIER NATURAL 90% TUNGSTEN

- › Barrel designs as used by Maestro Premiers
- › Natural Tungsten
- › Maestro Aluminium shafts
- › Premium wallet
- › Engraved Unicorn Hallmark



GARY ANDERSON

04073 18g



Gripper Finish



JAMES WADE

04106 20g

SILVER STAR™ 80% TUNGSTEN

- › Natural Tungsten
- › Gripper shafts
- › Compact case
- › Engraved Unicorn Hallmark



weight illustrated

THE POWER®

weight illustrated

RAYMOND van BARNEVELD

weight illustrated

JOHN LOWE

23132 18g
23133 20g

02827 17g
02828 19g

03212 18g
03213 20g

BLACK STAR 80% TUNGSTEN

- › Black Titanium PVD non-slip grip
- › Gripper shafts
- › Compact case
- › Engraved Unicorn Hallmark



THE POWER®

RAYMOND van BARNEVELD

23135 18g 04140 17g

BULLET® STAINLESS STEEL

STYLE MEETS VALUE

- › Super Durable Stainless Steel
- › XL Aluminium shafts
- › Compact case
- › Engraved Unicorn Hallmark



JOHN LOWE

RAYMOND van BARNEVELD

THE POWER®

03222 20g

weight illustrated

02835 17g
02836 19g

weight illustrated

23138 16g
23139 18g

BLACK BRASS

- › Matt Black brass barrels
- › XL shafts
- › Compact case
- › Engraved Unicorn Hallmark



weight illustrated



RAYMOND van BARNEVELD

04080 17g
04081 19g

weight illustrated



THE POWER®

23141 16g
23142 18g

BARNEY BRASS BRASS

5 TIMES WORLD CHAMPION RAYMOND van BARNEVELD ENDORSED

- › Colour coordinated
- › 100% brass barrels
- › Gripper shafts
- › Compact case



weight illustrated



02880 16g
02881 18g



02887 18g

weight illustrated



02889 16g
02890 18g

RAYMOND van BARNEVELD

HALLMARK

AFFORDABLE EXCELLENCE

SOFT TIP

MANTIS
90% TUNGSTEN

NEW

- › Positive sawtooth grip
- › Checkout finger grip tips
- › Gripper 3 shafts
- › Feature Mantis 75 micron flights
- › Engraved Unicorn Hallmark



04200 19g

04202 18g

B-FLY
90% TUNGSTEN

NEW

- › Checkout finger grip tips
- › Gripper 3 shafts
- › Feature B-FLY 75 micron flights
- › Engraved Unicorn Hallmark



04206 19g
Emperor

04204 18g
Admiral

AUTOGRAPH®
80% TUNGSTEN

- › Configured by and for lady players
- › Subtle total coordination
- › Gripper shafts
- › White Compact case
- › Fully coordinated accessories available



02870 19g

CC405
SATIN CHROME BRASS

- › Non-slip satin chrome brass darts
- › Fiesta Aluminium shafts
- › Compact case



weight illustrated

03342 18g

03343 20g



U-TECH

CUTTING EDGE TECHNOLOGY. PERFORMANCE ENHANCING

SOFT TIP

CORE XL T95 95% TUNGSTEN

- › Very high density Tungsten for super slim barrels
- › Gripper II shafts
- › Slimline case
- › Engraved Unicorn Hallmark
- › XL Bonus Pack of accessories comprising:
 - 2 sets of Gripper shafts,
 - 2 sets of polyester flights,
 - 8 flight protectors,
 - 6 spare Gripper rings,
 - 1 Checkout Chart



weight illustrated

03177 18g
03178 20g

CORE XL T80 80% TUNGSTEN

- › Great value enhanced Tungsten range
- › Gripper II shafts
- › Slimline case
- › Engraved Unicorn Hallmark
- › XL Bonus Pack of accessories comprising:
 - 2 sets of Gripper shafts,
 - 2 sets of polyester flights,
 - 8 flight protectors,
 - 6 spare Gripper rings,
 - 1 Checkout Chart



04088 17g 04089 18g 04090 19g

CORE XL STRIKER® 90% TUNGSTEN

- › Budget Tungsten dart sets
- › Gripper II shafts
- › Slimline case
- › XL Bonus Pack of accessories comprising:
 - 2 sets of Gripper shafts,
 - 2 sets of polyester flights,
 - 8 flight protectors,
 - 6 spare Gripper rings,
 - 1 Checkout Chart



90% TUNGSTEN
90% TUNGSTEN

02904 18g 02918 19g



- › Slimline case
- › Ultra slim
- › Durable

CORE PLUS TUNGSTEN

- › Precision engineered Tungsten barrels
- › Gripper II shafts
- › Compact footprint
- › Engraved Unicorn Hallmark
- › High impact shelf appeal
- › Complete with Dart Wallet



weight illustrated

04062 17g
04063 19g



CORE PLUS BLACK

- › Coated brass barrels
- › Gripper II shafts
- › Compact footprint
- › Engraved Unicorn Hallmark
- › High impact shelf appeal
- › Complete with Dart Wallet



weight illustrated

04083 17g
04084 19g



VALUE PRECISION ENGINEERED. NO NONSENSE VALUE

SOFT TIP

CORE PLUS BRASS

- › Precision machined brass barrels
- › Gripper II shafts
- › Compact footprint
- › High impact shelf appeal
- › Complete with Dart Wallet



weight illustrated

04065 17g
04066 19g

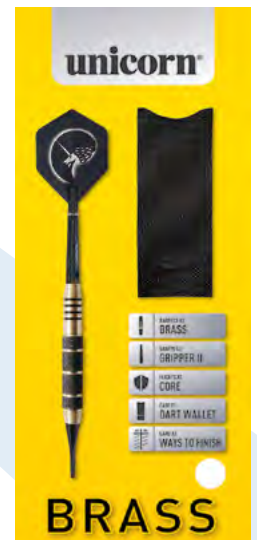

Wallet included in all
Core Plus packs



VALUE

PRECISION ENGINEERED. NO NONSENSE VALUE

SOFT TIP

CORE TUNGSTEN

- › Quality materials
- › Quality engineering
- › Budget price
- › Gripper shafts
- › Very compact footprint for best sales density
- › Engraved Unicorn Hallmark

CORE BRASS

- › Pure quality brass
- › Gripper shafts
- › Very compact footprint for best sales density

BAR DARTS BRASS

- › Only supplied to special order Brass barrels
- › Available in a range of Flight colours
- › 100 darts per master carton



weight illustrated

03673 17g
03674 19g



weight illustrated

03956 17g
03957 19g



71506/B Blue
71506/BK Black
71506/R Red
71506/G Green
71506/Y Yellow

CONTOUR TIP - LONG BLK STD S/T BRASS BARREL 1/4" x 1/4" 12g

MASS MERCHANT RANGE

CONTACT YOUR LOCAL UNICORN SALES OFFICE

SOFT TIP

- › Concise range
- › Concentrated turnover
- › Fully sealed packs
- › Clam or blister packed
- › Only available to special order



71748
6 sets per master carton



71751 16g 71752 18g
6 sets per master carton



71754 17g 71755 19g
6 sets per master carton



71756 16g 71757 18g
3 sets per master carton



71759 15g 71760 17g 3 sets per master carton



71762 16g 71763 18g 3 sets per master carton



71772 17g 3 sets per master carton



71765 16g 71766 18g 2 sets per master carton



71774 18g 3 sets per master carton



71769 18g 2 sets per master carton



71779 18g 2 sets per master carton



77872
6 sets per master carton

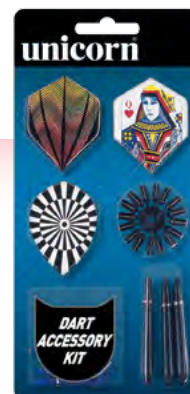

77873
6 sets per master carton



77874
6 sets per master carton

ECLIPSE® HD
BRISTLE

STOP PRESS
UNICORN ECLIPSE HD
SELECTED BY THE PDC FOR
SKY & GLOBAL TV DEBUT 2014



HD 20/20
WHITE DIGITAL
NUMBER RING
Registered Community Design
application no. 002044263

HD
WHITE
SPIDER

HD
STAPLE-FREE
WHITE BULLSEYE

SEAMLESS PLAYING SURFACE
FOR HIGH SCORES



**HIGH DEFINITION
PROFESSIONAL
DARTBOARD**

- > Patent pending
- > Seamless playing surface for higher scores
- > HD 20/20 White digital number ring
- > HD White spider
- > HD White bullseye

79437 3 boards per master carton



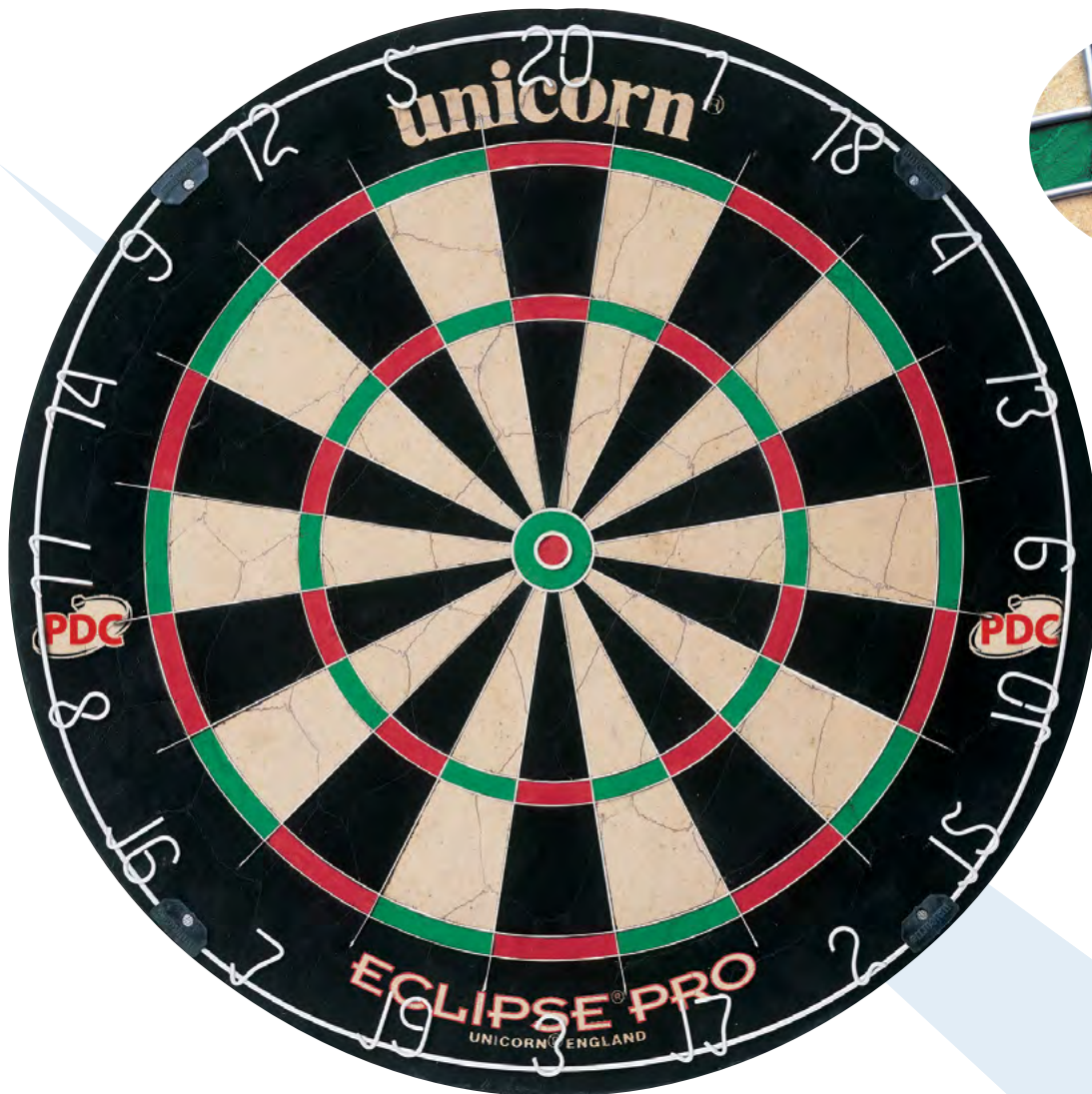

THE INDUSTRY
LEADING DARTBOARD
SEEN BY MILLIONS OF
VIEWERS ON TV

THE PROFESSIONAL DARTS
CORPORATION CHOOSE AND
RECOMMEND ONLY
UNICORN DARTBOARDS



- › As used in all PDC tournaments
- › Championship quality bristle board
- › PDC endorsed
- › Designed to maximise averages
- › Unicorn high technology wiring design
- › Completely staple-free construction
- › Ultra-slim segmentation system – 30% thinner than conventional round wire boards
- › Increased target area – especially in Doubles and Trebles
- › Ultra high visibility number ring and spider
- › Staple-free Bullseye

79403 5 boards per master carton

ECLIPSE® HD TRAINER BRISTLE

HD 20/20
WHITE DIGITAL
NUMBER RING
Registered Community Design
application no. 002044263



- > Dedicated practice board
 - > Ultra slim doubles and trebles
 - > Patent pending
 - > Seamless playing surface for higher scores
 - > HD 20/20 White digital number ring
 - > HD White spider
 - > HD White micro bullseye
- 79438** 2 boards per master carton



SEAMLESS
PLAYING SURFACE
FOR HIGH SCORES

STRIKER® BRISTLE



- > Competition quality bristle board
 - > PDC endorsed
 - > High quality round wire construction
 - > **SuperSlim™** wire fasteners to increase playing area
 - > Staple-free Bullseye
- 79383** 5 boards per master carton



DB180
BRISTLE

DARTBOARDS

UNICORN DARTBOARD RANGE – THE INDUSTRY STANDARD



- › Great value, budget bristle
 - › Competition quality bristle board
 - › PDC endorsed
 - › Full size playing area
 - › High quality round wire construction
 - › SuperSlim™ wire fasteners to increase playing area
 - › Staple-free bullseye
 - › Checkout Chart on carton
- 79432** 5 boards per master carton



XL
PAPER



- › Full size playing surface
 - › Top quality coiled paper dartboard
 - › Double sided
 - › Size 17" x 3/4"
 - › Complete with 2 sets of darts
- 79085** 6 boards per master carton

ELECTRONIC DARTBOARDS

STEEL TIP ELECTRONIC DARTBOARD

eBristle

Unicorn introduce eBristle dartboards, the latest generation of electronic bristle boards featuring the advantage of a bristle rich playing surface with the fun and convenience of auto scoring. Now, you no longer need alternate sets of steel and soft tip darts, with a Unicorn eBristle board, enjoy the look and feel of a bristle board and the consistency of using your regular darts of choice.



- › Suitable for up to 8 players
 - › 32 games with 256 variations
 - › LCD automatic scoring display
 - › Includes 6 steel tip darts
 - › Special order only
 - › Requires 3 AA batteries (not included)
- 79650** 3 boards per master carton

SOFT TIP ELECTRONIC HOME DARTS CENTRE



- › Suitable for up to 8 players
 - › 32 games with 256 variations
 - › LCD automatic scoring display
 - › Includes 6 soft tip darts
 - › Special order only
 - › Requires 3 AA batteries (not included)
- 79509** 3 boards per master carton



SOFT TIP ELECTRONIC DARTBOARD



- › Suitable for up to 8 players
 - › 25 games with 176 variations
 - › LCD automatic scoring display
 - › Includes 6 soft tip darts
 - › Requires 3 AA batteries (not included)
- 79511** 6 boards per master carton

SOFT TIP ELECTRONIC DARTBOARD



- › Suitable for up to 8 players
 - › 25 games with 176 variations
 - › LCD automatic scoring display
 - › Play against the computer feature
 - › Includes 6 soft tip darts
 - › Requires 3 AA batteries (not included)
- 79505** 6 boards per master carton



- › Wooden cabinet with shaped doors
 - › Wipe-clean whiteboards on door inners for scoring
 - › Striker bristle dartboard with **SuperSlim™** wire fasteners and staple-free Bullseye
 - › Complete with 2 sets of darts
 - › PLUS marker pen and wiper
 - › PLUS Checkout Chart
- 46136** 2 cabinets per master carton

STRIKER®
BOARD & SURROUND
HOME DARTS CENTRE



- › Striker EVA dartboard surround
 - › Striker bristle dartboard
 - › Complete with 2 sets of darts
- 46122** 2 per master carton

DB180
HOME DARTS CENTRE



- › Fold out construction for wall protection
 - › Incorporates 2 wipe clean scoreboards
 - › Unicorn DB180 Bristle Dartboard
 - › 2 sets of darts
 - › Marker pen and wiper
 - › Dart and marker pen holder
- 46165** 3 per master carton

SURROUNDS, CLAMPS & CABINETS

PERFORMANCE, INNOVATION AND VALUE



TEKNIK™ CABINET

- › Tough, stylish aluminium frame
 - › Unique adjustable fixing system
 - › Fits 18" bristle or paper boards from 3/4" to 1 1/2" thick
 - › Includes Checkout Chart and oche
- 46020** 3 cabinets per master carton
Dartboard & Darts not included

STRIKER® EVA DARTBOARD SURROUNDS

- › Lightweight injection moulded EVA protection ring
- › Holds dart points securely
- › Virtually eliminates the risk of 'bounce-outs' from near misses
- › Protects surrounding area from accidental surface marks and damage
- › Clamps around a standard bristle dartboard with no fixings required
- › Dartboard not included



79363 Blue **79360** Red **79361** Black
Master pack of 5 one colour

PROFESSIONAL DARTBOARD SURROUNDS

- › Ultra heavy duty
- › Injection moulded plastic protection ring
- › High density material holds dart points securely
- › Virtually eliminates the risk of 'bounce-outs' from near misses
- › Protects surrounding area from accidental surface marks and damage
- › Clamps around a standard bristle dartboard with no fixings required
- › Dartboard not included



79374 Red **79375** Blue **79376** White **79378** Green **79373** Black
Master pack of 5 one colour

SURROUNDS, CLAMPS & CABINETS

PERFORMANCE, INNOVATION AND VALUE



Colour of veneer may vary

ORIGINAL CABINET

- › Budget home cabinet
 - › Classic compact size
 - › Accommodates full size bristle dartboard
- 46012** 2 cabinets per master carton



DARTBOARD WALL CLAMP

- › Robust spring-loaded clamp securely holds a bristle dartboard
 - › Wall mounted
 - › Fixing kit and full instructions supplied
 - › Allows board to be rotated as required
 - › Ideal for use in conjunction with the Unicorn Dartboard Surround
- 79379** Dartboard not included

TEKNIK 360 MAGNETIC DARTBOARD HOLDER

- › PATENT APPLIED FOR NO. GB0911142.8
 - › Clever two piece all metal design locates board securely and safely on wall
 - › Innovative construction gives precise rotation and vertical alignment
 - › Easy up! Supplied with fixing kit and instructions
- 79427** 6 holders per master carton

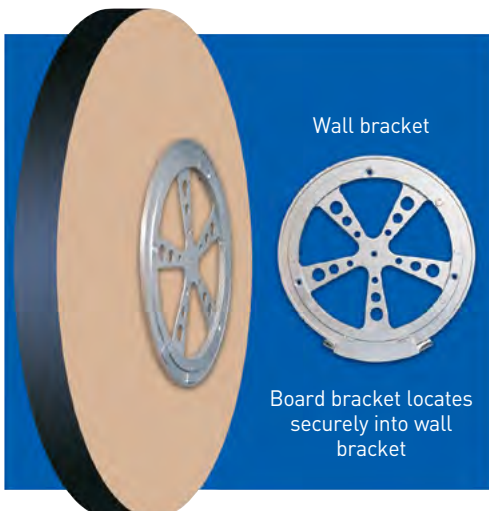

ACCESSORIES

PERFORMANCE, INNOVATION AND VALUE



PRO DARTMATE

- › The Ultimate Free Standing Board and Oche Assembly
 - › Sturdy construction for maximum stability
 - › 4 adjustable feet
 - › Integral backboard with 2 scoreboards
 - › Marker pen and wiper
 - › Eclipse Pro dartboard
 - › OcheMate
 - › Strong zipped carry bag
 - › 106cm x 74cm x 24cm - 24 kg
- 85178** Master pack of 1
(Raised Oche not included)



RAISED OCHE

- › Lightweight
- › 4 piece clip together construction
- › Raised toe line
- › Fully adjustable for length
- › Can be set to compensate for most thicknesses of skirting board
- › Complete with zipped carry bag
- › 63cm x 60cm x 4cm - 7 kg

86656
Master pack of 3



UNICORN ON TOUR

The ultra portable system that enables you to use your dartboard in virtually any location that has a door!

The system comprises:-

- › Unicorn Eclipse Pro Board
- › Unicorn OcheMate for precise set-up
- › Unicorn short Oche mat
- › Dartboard mounting with adjustable door fixing and external safety warning notice
- › Complete with specially designed convenient carry bag
- › 48cm x 48cm x 10 cm - 7 kg

46001 Master pack of 1



unicorn
The Big Name in Darts®

ULTRA PORTABLE SYSTEM THAT ENABLES YOU TO USE YOUR DARTBOARD IN VIRTUALLY ANY LOCATION THAT HAS A DOOR!

STYLISH CARRYING CASE

EASY TO ASSEMBLE ON THE DOOR

ADJUSTABLE BUCKLES TO STOP SLIPPAGE

INCLUDES UNICORN ECLIPSE PRO BOARD

WORLD CHAMPION SERIES

unicorn
ON TOUR

THE ULTIMATE PORTABLE SYSTEM

SCOREBOARD

- Extra large wipe clean scoreboard
 - Size 400 x 570mm (15³/₄ x 22¹/₂" approx)
 - Complete with Marker Pen
 - Magnetic wiper park
- 46003** Master pack of 1



STRIKER® DART MAT

- Lightweight EVA dart mat
 - International throwing line marked as well as 8ft line
- 86324** RED
Master pack of 1
- 86655** BLACK
Master pack of 1



PROFESSIONAL DART MAT

- Heavy duty rubber dart mat
 - International throwing line marked as well as 8ft line
- 86055** Master pack of 1

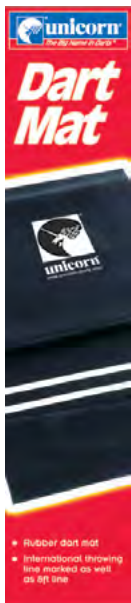

DARTMATE

- The improved version of the original Free Standing Board & Cabinet
 - Used by most of the world's best known players
 - Holds the board at the regulation height
 - Fully portable – folds down into 2 easily carried packs
 - Can be used anywhere
 - Ideal for exhibitions or practice
 - Complete with full instructions
 - Includes Eclipse Pro tournament bristle dartboard
 - Includes OcheMate
 - 136 x 16 x 17 cm - stand
 - 12 x 51 x 51 cm - cabinet total weight with board and printed cartons 12 kg
- 85139** Master pack of 1 (comprises 2 cartons)



OCHÉ

- Self adhesive Oche



86053 Master pack of 1

OCHEMATE

- At last, a simple and foolproof way to set up a dartboard ready for tournament play
- Incorporates a unique measure for the diagonal from the Oche to the centre Bullseye
- Also measures both vertical and horizontal dimensions
- Complete with easy to follow instructions

76115 Master pack of 6



SELECTING UNICORN FLIGHTS

UNICORN FLIGHT DESIGNS ARE UNIQUE AND ARE ONLY AVAILABLE FROM UNICORN

THE UNILAB FLIGHT SELECTOR TABLE

The UniBoffin Explains:

The right flights for you must match your particular darts, producing enough aerodynamic lift to stabilise them in-flight but not so much as to throw them off-course. UniLab and Unicorn Sigma darts use sophisticated mathematics to achieve this matching, but you can try yourself using the following table, some experimentation, and maybe a UniLab Flight Selector Kit!

The table below lists the surface area for current Unicorn flight shapes, a Lift Factor relative to the highest lift Big Wing flights, and a related Stability Factor. Flight weight also affects stability and, although the Stability Factor shown is for a standardised material, the table's last row shows the weight of a representative Plus flight in different materials. Heavier materials provide slightly less stability but improved durability, Maestro additionally offers more rigidity and therefore consistency of flight, and Q aims to provide this in a lighter flight.

There are no hard-and-fast rules on flights matching, but as a hint to using the table, if your darts are landing in the board at varying angles, try a higher stability flight, if they're landing true, a smaller, lower lift flight may improve accuracy, land flatter, and reduce bed-blocking.

FLIGHT SHAPE	AREA cm ²	LIFT FACTOR	STABILITY FACTOR (standardised material)	CHARACTERISTICS & COMMENTS			
Big Wing	44.741	1.00	1.00	The most lift from the biggest flight!			
Plus	39.614	0.87	0.93	A favourite all-purpose compromise			
Fin	38.765	0.78	0.90	An Xtra take off from a retro rocket			
Xtra	36.323	0.74	0.85	Works well with a straighter throw			
Slim	32.846	0.57	0.59	Works well with a flatter, direct throw			
DXM	26.585	0.51	0.57	For when you are playing at your best			
Sigma Flights				Mathematically matched to Sigma darts			
One	37.519	0.93	1.05	Stability-optimised stall-resistant design			
Pro	29.249	0.66	0.74	For accuracy with side-loading shafts			
Super Pro	25.265	0.55	0.59	Shorter for accuracy with end-loaders only			
WEIGHT OF A PLUS FLIGHT IN DIFFERENT MATERIALS (g)							
Core .75	Q .75	Q .100	Maestro .100	Super Maestro .125	One.100	Pro.100	Super Pro.100
0.53g	0.53g	0.65g	0.65g	0.75g	0.60g	0.48g	0.42g

SEE TABLE BELOW FOR FLIGHT SHAPE SYMBOLS

UNILAB FLIGHT SELECTOR KIT

- > A direct spin-off from UniLab, our unique online Darts Tuning application, the UniLab Flight Selector Kit enables you to experiment with different flight configurations.
- > Different flight shapes and sizes will alter a dart's trajectory, working aerodynamically in conjunction with your existing barrels and shafts.
- > Try these 5 different shapes to tweak your darts set up to improve your accuracy and consistency.

Try UniLab for yourself and read more about the science of darts at www.unicorn-darts.com



77790 Master pack of 12



Refer to symbols, Select P B S X D or F, Quote item number. Flights are supplied blister carded, 12 sets per pack.

<p>P PLUS 39.614cm² The original Unicorn Flight shape that's now copied as a standard shape worldwide as it's an ideal general purpose flight that suits all styles of play and Dart/Shaft combinations.</p>	<p>B BIG WING 44.741cm² These Extra Large Flights (+13% bigger than Plus shape) give Extra Lift and are becoming increasingly popular with top players.</p>	<p>S SLIM 32.846cm² Lightweight Flights for lighter weight Darts, especially soft tip where they're used by most of Unicorn's top players.</p>	<p>X XTRA 36.323cm² For accurate players, the unique Xtra shape allows the closest groupings.</p>	<p>D DXM 26.585cm² For consistently accurate players these ultra compact flights improve visibility and close grouping.</p>	<p>F FIN 38.765cm² For improving players, step up to Fin to improve grouping.</p>
--	---	--	---	---	---

Sigma™ .100 CUTTING EDGE TECHNOLOGY. PERFORMANCE ENHANCING.

100 MICRON NOMINAL MATERIAL THICKNESS.



SIGMA SUPER PRO
68447 WHITE



SIGMA SUPER PRO
68448 SILVER



SIGMA SUPER PRO
68536 BLACK



SIGMA ONE 68434



SIGMA ONE 68537



SIGMA ONE 68263



SIGMA PRO 68262



SIGMA PRO 68394



SIGMA PRO 68433



SIGMA PRO 68538

Q⁹ .100 & .75 SUPER-WAVE RIBBED FLIGHTS. INCREASED RIGIDITY, BETTER FLIGHT STABILITY.

100 & 75 MICRON NOMINAL MATERIAL THICKNESS.

Q .100



P 68509

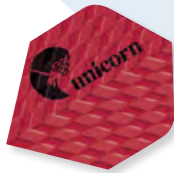

P 68511



P 68510



S 68499 P 68496
Raymond van Barneveld



S 68501 P 68497
Raymond van Barneveld



P 68505 F 68532



P 68504



D 68513



S 68512



P 68577 F 68533

Q .75



P 68540 B 68541
F 68542



P 68543 B 68544
F 68545



P 68546 B 68547
F 68548



P 77615

Super Maestro® .125 SUPER RIGID. ULTRA DURABLE.

125 MICRON NOMINAL MATERIAL THICKNESS.



P 68517 D 68549
B 68550 F 68551



P 68515 D 68552
B 68553 F 68554



P 68516 D 68555
B 68556 F 68557

Maestro®.100 THE CHOICE OF MANY TEAM UNICORN PROFESSIONALS. 33% THICKER THAN CORE.75 FOR INCREASED RIGIDITY.

100 MICRON NOMINAL MATERIAL THICKNESS.



NEW

S 68354 P 68357
X 68358 D 68425
B 68569



S 68355 P 68359
X 68360 D 68426



NEW

S 68408 P 68406
X 68407 D 68413
F 68570



NEW

S 68443 P 68571
X 68572 D 68444



NEW

S 68441 P 68573
X 68574 D 68442



P 68144

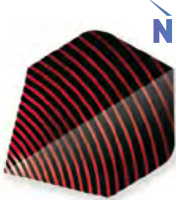

NEW

P 68528 F 68529

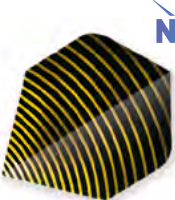

NEW

P 68526 F 68527



P 68134



P 68240



P 68233



P 68234



P 77683 S 77684
D 68481



P 77686



P 77687 S 68193
X 68194 D 68483



P 77688 S 77689
X 68195 D 68484
B 68112 F 68539



P 77690 S 77695
X 68196 D 68482
B 68113 F 68560



P 77681



P 77780



P 77778



P 77779



P 68109



P 68103 B 68102



P 68172



P 68491



B 68245
1 flight 2 different faces



P 68142
1 flight 2 different faces

Refer to symbols, Select P B S X D or F, Quote item number. Flights are supplied blister carded, 12 sets per pack.

P PLUS 39.614cm²
The original Unicorn Flight shape that's now copied as a standard shape worldwide as it's an ideal general purpose flight that suits all styles of play and Dart/Shaft combinations.

B BIG WING 44.741cm²
These Extra Large Flights (+13% bigger than Plus shape) give Extra Lift and are becoming increasingly popular with top players.

S SLIM 32.846cm²
Lightweight Flights for lighter weight Darts, especially soft tip where they're used by most of Unicorn's top players.

X XTRA 36.323cm²
For accurate players, the unique Xtra shape allows the closest groupings.

D DXM 26.585cm²
For consistently accurate players these ultra compact flights improve visibility and close grouping.

F FIN 38.765cm²
For improving players, step up to Fin to improve grouping.

Authentic .100 & .75 UNICORN FLIGHT DESIGNS ARE UNIQUE AND ONLY AVAILABLE FROM UNICORN.

100 & 75 MICRON NOMINAL MATERIAL THICKNESS.

Authentic .100

NEW



B 68490 Gary Anderson Competition



B 68466 Flying Scot Gary Anderson



B 68464 S 68465 Gary Anderson



NEW

B 68485 P 68486 Raymond van Barneveld

Authentic .75



S 77993 Bob Anderson



P 68400 S 68401 Raymond van Barneveld



P 68396 S 68397 Anastasia Dobromyslova



X 77665 John Lowe



S 68402 Raymond van Barneveld



S 68398 Anastasia Dobromyslova

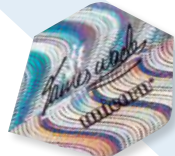

P 77116 S 77114 James Wade

NEW



X 68523 Paul Nicholson



X 68440 Kevin Painter



P 68439 Andy Hamilton



P 68454 Wez 'the Warrior' Newton



P 68436 James Wade



P 68435 Terry Jenkins



P 68403 Raymond van Barneveld

Core .75 STRIKING HOLOGRAM, METALLIC & PHOTO-REALISTIC POLYESTER FLIGHTS.

75 MICRON NOMINAL MATERIAL THICKNESS.



P 68563



P 68564



P 68565



P 68566



P 68558 F 68559



P 68341

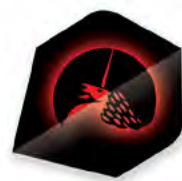

P 68337



P 68339 X 68340



P 77394



P 77443



P 77380 Two-sided flight



P 77290 Supplied assorted



P 77407



P 68431



P 68503



P 68506



P 68507



P 68508



P 77748



P 77300 1 flight 2 different faces



P 68025 1 flight 2 different faces



P 68429 1 flight 2 different faces



P 68480 1 flight 2 different faces

Refer to symbols, Select P B S X D or F, Quote item number. Flights are supplied blister carded, 12 sets per pack.

P PLUS 39.614cm²
The original Unicorn Flight shape that's now copied as a standard shape worldwide as it's an ideal general purpose flight that suits all styles of play and Dart/Shaft combinations.

B BIG WING 44.741cm²
These Extra Large Flights (+13% bigger than Plus shape) give Extra Lift and are becoming increasingly popular with top players.

S SLIM 32.846cm²
Lightweight Flights for lighter weight Darts, especially soft tip where they're used by most of Unicorn's top players.

X XTRA 36.323cm²
For accurate players, the unique Xtra shape allows the closest groupings.

D DXM 26.585cm²
For consistently accurate players these ultra compact flights improve visibility and close grouping.

F FIN 38.765cm²
For improving players, step up to Fin to improve grouping.

Core .75 STRIKING HOLOGRAM, METALLIC & PHOTO-REALISTIC POLYESTER FLIGHTS.

75 MICRON NOMINAL MATERIAL THICKNESS.



P 68428



P 68432



P 68427



NEW

P 68324 X 68325
F 68561



NEW

P 68388 S 68390
F 68562



P 68335



P 77296



NEW

P 68375 X 68376
S 68377 F 68575



P 68332



P 68322



P 68319



P 77328

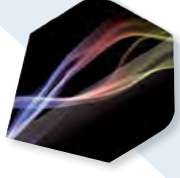

P 68368



P 77409



P 68243



NEW

P 77763 X 68205
B 68206 F 68567



NEW

P 77760 B 68208
F 68568



P 77750



P 77402



P 77401 1 flight 2 different faces



P 68430



P 77717



P 77766 B 68214



P 68381



P 77559



P 68224



P 77404 1 flight 4 different faces



X 77454 1 flight 4 different faces

CARBON ACCESSORIES

SUPER-TOUGH, SUPER-LIGHT CARBON FIBRE SHAFTS & NOSE CONE



CARBON FIBRE SHAFTS

Aerospace developed Carbon Fibre for outstanding rigidity and strength for any given diameter.

High performance, outstanding strength : weight ratio

unicorn®

NEW

OMEGA® SLIM

- > Super-tough, Super-rigid carbon fibre shaft
- > Co-polymer adaptor
- > **Small Thread**
- > **Length** 44.0mm
- > **Weight** 0.67g



78717

XTC CARBON

- > Super-tough, Super-light carbon fibre shaft
- > Made entirely from Carbon Fibre
- > **Small Thread**
- > **Length** 45.6mm
- > **Weight** 0.61g



78606

BANTAM™ CARBON

- > Co-polymer flight holder
- > Carbon fibre shaft
- > Aluminium base
- > Shaft can be cut to length
- > **Small Thread**
- > **Length** 53.0mm
- > **Weight** 0.90g

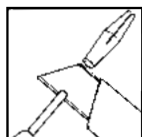

Length adjustable: Remove top, cut off to desired length, replace top.



78605

Spare tops for use with Bantam™ Carbon and JetStem® Carbon shafts



78227

NEW

OMEGA® CARBON

- > Super-tough, Super-rigid carbon fibre shaft
- > Made entirely from Carbon Fibre
- > **Small Thread**
- > **Length S** 33.0mm **M** 44.3mm
- > **Weight S** 0.87g **M** 1.14g



78609 78607

JETSTEM® CARBON

- > Carbon fibre shaft
- > Aluminium flight holder and base
- > **Small Thread**
- > **Length** 50.8mm
- > **Weight** 1.16g



78603

SIGMA™ SUPER PRO CARBON

- > Super-tough, Super-light carbon fibre shaft
- > Made entirely from Carbon Fibre
- > Optimised for use with Sigma Darts
- > **Small Thread**
- > **Length** 45.3mm
- > **Weight** 0.65g



78690

SIGMA™ ZERO D CARBON NOSE CONE

SIGMA™ 25mm Plain
SIGMA™ 25mm Finger grip

All fitted with steel points. Sets of 3 packed in dozens of one length

TO SEE OUR FULL RANGE OF NOSE CONES AND SPARE POINTS GO TO PAGE 64



78035 78036

Whilst carbon fibre exhibits tremendous strength for any given weight, flights and shafts are the consumable items in the sport of darts and will need periodic replacement. Shaft lengths stated exclude the thread.

- > Simple and secure side loading design
- > 100% Titanium base
- > Durable hi-flex flight holder
- > Built in flight protector
- > Added grip to base of shaft
- > Replaceable flight holders
- > **Small Thread**
- > **Length** 74.4mm
- > **Weight** 1.97g



78664 78665 78669 78688 78689

Sigma™ Shafts

SIGMA™ PRO Ti

- > Simple and secure side loading design
- > 100% Titanium base
- > Durable hi-flex flight holder
- > Built in flight protector
- > Optimised for use with Sigma Pro Darts
- > Replaceable flight holders
- > **Small Thread**
- > **Length** 74.4mm
- > **Weight** 1.97g



78653 78684

SIGMA™ PRO MAGNESIUM

- > Ultra light Magnesium alloy base
- > Simple and secure side loading design
- > Durable hi-flex flight holder
- > Built in flight protector
- > Replaceable flight holders
- > **Small Thread**
- > **Length** 74.4mm
- > **Weight** 1.04g



78604

SIGMA™ SUPER PRO MAGNESIUM

- > Ultra light
- > Magnesium alloy
- > **Small Thread**
- > **Length** 45.0mm
- > **Weight** 0.90g



78610

SIGMA™ CR

- > Optimised carbon polymer mix
- > Light, strong, flexible
- > Sigma certified
- > **Small Thread**
- > **Length** S 34.4mm M 44.2mm
- > **Weight** S 0.78g M 1.03g



78725 78726

SIGMA™ ONE

- > Specifically designed rigid shafts
- > Optimised for use with Sigma One Darts
- > **Small Thread**
- > **Length** 46.3mm
- > **Weight** 0.67g



78654

PHASE 5/SIGMA™ SPARE TOPS

- > Screw-in spare flight holders



78597 78595 78598 78596 78599 78600

XL Shafts

XL Ti

- > 100% Titanium
- > Ultra strong
- > Virtually unbreakable
- > **Small Thread**
- > **Length** S 35.3mm M 45.2mm
- > **Weight** S 1.63g M 2.02g

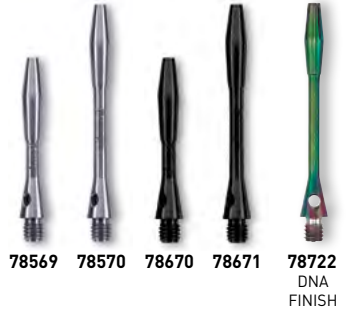

78569 78570 78670 78671 78722 DNA FINISH

XL ANODISED ALUMINIUM

- > Anodised aluminium alloy shaft
- > **Small Thread**
- > **Length** S 35.1mm M 45.6mm
- > **Weight** S 1.15g M 1.32g



78294 78296

XL ALUMINIUM

- > Precision natural aluminium alloy shaft
- > **Small Thread**
- > **Length** S 35.1mm M 45.6mm
- > **Weight** S 1.15g M 1.32g

VALUE PACK 5 SETS

Medium 78289



78280 78281



XL+

- > Ultra longlife, retains flexibility and recovers shape even after many hours of play
- > **Small Thread**
- > **Length** S 33.7mm M 46.5mm
- > **Weight** S 0.55g M 0.67g



78150 78152

SlikStik Shafts

SLIKSTIK®

Probably the best dart shaft in the world

- > Ultra longlife 21st century material
- > Retains shape and flexibility
- > Perfect in-flight balance
- > Easiest possible side-load action
- > Flight held securely
- > Built-in flight protector
- > Choice of lengths

- > **Length** S 56.6mm M 72.3mm
- > **Weight** S 0.46g M 0.70g

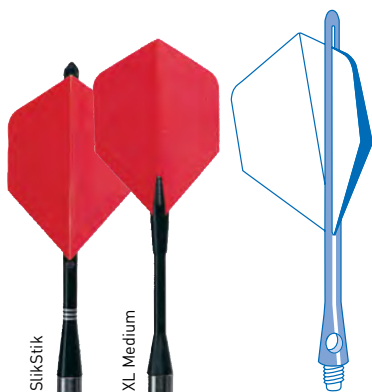

SLIKSTIK®



- > Now available in two lengths
- > High flex strength
- > **Small Thread**

- > **Length** S 56.6mm M 72.3mm
- > **Weight** S 0.46g M 0.70g



74121 74123 74129 74140 74194 74187

SlikStik® Aluminium

- > Ultra light anodised aluminium adaptor
- > Choice of colours
- > **Small Thread**

- > **Length** S 65.5mm M 74.5mm
- > **Weight** S 1.00g M 1.29g



74431 74432 74435 74436 74437 74441 74442 74445 74446 74447

Shaft lengths stated exclude the thread.

Aluminium Shafts

MAESTRO®

- > Diamond cut anodised aluminium alloy shaft
- > Length 50mm - 10% longer than standard 46mm shafts
- > **Small Thread**
- > **Length** 50.9mm
- > **Weight** 2.07g



78350

GT ALUMINIUM

- > Anodised aluminium shafts
- > Knurled design for extra grip
- > **Small Thread**
- > **Length** S 35.2mm M 45.7mm
- > **Weight** S 1.28g M 1.50g



78672 78673

ALI 360™

- > Aluminium dart shafts with fully rotating tops
- > Longer slots give greater flight engagement
- > **Small Thread**

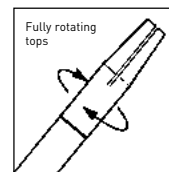

- > **Length** U 34.6mm S 39.9mm M 45.1mm
- > **Weight** U 1.29g S 1.54g M 1.77g



78626 78627 78628

WORLD CHAMPION™

- > Spiral diamond cut anodised aluminium alloy shaft
- > **Small Thread**

- > **Length** S 34.9mm M 45.2mm

- > **Weight** S 1.14g M 1.54g



78573 78578

FLAIR®

- > Anodised aluminium shaft
- > Self-lock adaptor
- > Acetal co-polymer adaptor
- > Stays locked
- > No fiddly washers
- > **Small Thread**

- > **Length** M 45.3mm
- > **Weight** M 1.42g



78252

MACHINA™



- > Deep machined aluminium
- > Great back end grip for control
- > **Small Thread**

- > **Length** 44.3mm
- > **Weight** 1.85g



78724 78721

CHECKOUT®

- > Flexible moulded shafts
- > Anodised aluminium tops
- > **Small Thread**

- > **Length** S 31.9mm M 50.5mm
- > **Weight** S 0.81g M 1.12g



78561 78562 78563 78564 78565 78566 78567 78568

Moulded Shafts

GRIPPER® GT

- > Moulded shafts with extra finger grip
- > Spring compression for security
- > **Small Thread**

> **Length** **S** 33.4mm **M** 44.2mm
 > **Weight** **S** 0.79g **M** 1.08g



78674 78678 78680 78676 78682 78675 78679 78681 78677 78683

GRIPPER® 360

- > Full 360° rotating shafts
- > Alloy tipped flight holders
- > **Small Thread**

> **Length** **U** 35.0mm **S** 40.1mm **M** 44.9mm
 > **Weight** **U** 0.95g **S** 1.04g **M** 1.13g

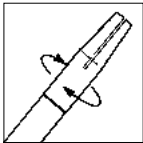

Fully rotating tops



78660 78661 78662

GRIPPER® 3 **NEW**

- > Moulded shafts
- > New profile
- > Easi-flight load
- > Super lock flight hold
- > Spring compression for security
- > **Small Thread**

> **Length** **S** 34.4mm **M** 44.2mm
 > **Weight** **S** 0.78g **M** 1.03g



Short Medium



Length
 Short 78702 78706 78710
 Medium 78703 78707 78711



**VALUE PACKS
 5 SETS**

Black 78616
 White 78619
 Short 78617
 Medium 78620



**CANISTER
 MEGA PACK:
 CONTAINS 45
 SHAFTS**

Black Medium
 78501

6 canisters per Master carton

Shaft lengths stated exclude the thread.

SHAFTS

REPEAT CONSUMABLES

GRIPPER® 2

- > Moulded shafts
- > Spring compression for security
- > **Small Thread**

> **Length** **U** 27.4mm **S** 32.7mm **M** 44.0mm
 > **Weight** **U** 0.67g **S** 0.75g **M** 1.03g



Ultra Short Short Medium

**VALUE PACKS
 5 SETS**

Short 78613
 Medium 78614



Length
 Ultra Short 78146 78546 78549 78555 78558 78531
 Short 78145 78547 78550 78556 78559 78532
 Medium 78148 78548 78551 78557 78560 78533

Shaft lengths stated exclude the thread.



CATALYST®

- > Moulded shafts
- > Spring compression grips the flight for extra security
- > **Small Thread**

> **Length** **S** 36.0mm **M** 44.4mm
 > **Weight** **S** 0.85g **M** 1.04g

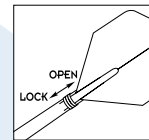

78622 78624
 Short Medium

Specialist

JETSTEM®

- > Slim, light, durable hardened, tempered, plated steel shaft with acetal co-polymer adaptor and replaceable Jet Tops
- > **Small Thread**

> **Length** **S** 45.4mm **M** 49.8mm
 > **Weight** **S** 1.21g **M** 1.37g

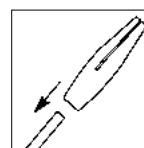

78218 78224

JET TOPS

- > For JetStem®. JetStem® Carbon and Bantam™ Carbon shafts



78227

THREAD WASHERS WITH APPLICATOR

- > Pack of 25
 78237



CONVERTA 360 SPARE POINTS

- > Converts soft tip darts to steel tip in seconds
- > Lengths short 7/8" & long 1 1/8"
- > Points rotate allowing following darts to deflect

78589 – Short Red

78590 – Short Black

78593 – Long Red

78594 – Long Black

Sets of 3 packed in dozens of one length, one colour

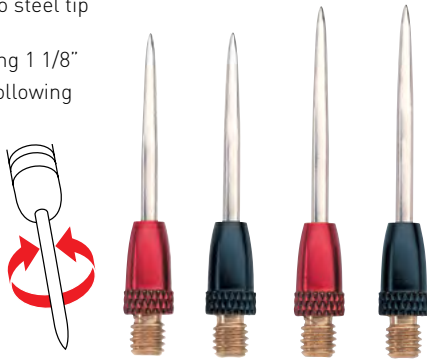

UNITOOL 1

- > Quick and easy repointing tool.
- > For use with all Unicorn darts and points.
- > Will not put a strain on the dart
- > Assured alignment of point and barrel
- > Complete with 6 standard, 6 short, 6 finger and 6 board points
- > Available in Black and Pink Power!

46094 Black 1 per pack

46141 Hi Viz 1 per pack



REPLACEMENT POINTS WITH ENGINEERED GRIPS

- > Cards of 3 of a pattern:

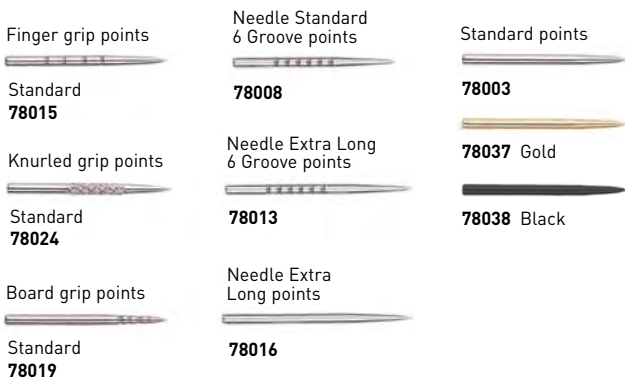

NEW

NEW

SIGMA™ ZeroD TITANIUM NOSE CONES

78030 – SIGMA™ ZeroD 25mm Plain

78031 – SIGMA™ ZeroD 25mm Finger grip

78040 – SIGMA™ ZeroD 28mm Plain

78041 – SIGMA™ ZeroD 28mm Finger grip

All fitted with steel points.
Sets of 3 packed in dozens of one length



SIGMA™ ZeroD CR NOSE CONES

78045 – SIGMA™ ZeroD CR 25mm Plain

78046 – SIGMA™ ZeroD CR 25mm Finger grip

78055 – SIGMA™ ZeroD CR 28mm Plain

78056 – SIGMA™ ZeroD CR 28mm Finger grip

All fitted with steel points.
Sets of 3 packed in dozens of one length



Spare Soft Tips

- > To special order only, spare tips are also available in bags of 1,000 as follows:



Contour Long Small



Contour Long Standard



Checkout Small

- **40020** Contour Tips - Long White SML
- **40021** Contour Tips - Long Black SML
- **40022** Contour Tips - Long Neon Yellow SML
- **40024** Contour Tips - Long Blue SML
- **40025** Contour Tips - Long Red SML
- **40027** Contour Tips - Long Neon Pink SML

- **40030** Contour Tips - Long White STD
- **40031** Contour Tips - Long Black STD

- **40061** Checkout Tips - Black SML



Teknik Small



Contour Short Small



Checkout Finger Grip

- **40040** Teknik Tips - White SML
- **40041** Teknik Tips - Black SML
- **40042** Teknik Tips - Neon Yellow SML
- **40044** Teknik Tips - Blue SML
- **40045** Teknik Tips - Red SML

- **40010** Contour Tips - Short White SML

- **40260** Checkout Tips - Finger Grip White
- **40261** Checkout Tips - Finger Grip Black

NEW

SIGMA™ SOFT TIPS

79026 – Sigma Spare Tips (clear) 50 up





CHECKOUT® SOFT TIPS

- Available from stock in the following assortments:
 - 79023** – Value blister of 50 assorted red/black
 - 79030** – Canister of 200 assorted red/black
 - 40061** – Bulk pack of 1,000 black only
 - 79079** – Finger grip black - 50 up **NEW**

MAESTRO® DARTS TUNE-UP KIT

- Contains Checkout Card, 8 sets of flights, 6 SlikStik shafts, 9 Gripper shafts, 6 XL shafts, 48 Ozones locking rings, 48 flight protectors and Jiffy dart sharpener
- 46111** 3 kits per master carton



FLIGHTMATE

- Neatly stores new or used flights
- Protects them against damage
- Holds up to 12 flights
- 76120** 12 FlightMates per pack

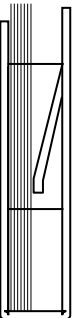

FLIGHT PROTECTORS

- Clips over the top of the dart flight
- Protects flights from damage by following darts
- 78222** Clear
- 78225** Black
- 8 protectors per card
- 12 per pack

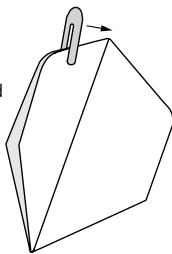

PRO FLIGHT PROTECTORS

- Lightweight aluminium
- Clips over the top of the dart flight
- Protects flights from damage from following darts
- 78223** Natural
- 78226** Black
- 12 sets per pack

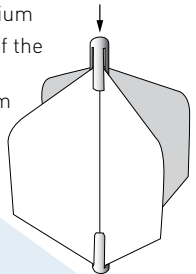

JIFFY® DART SHARPENER

- The original abrasive sharpening stone
- Best quality vitrified silicon carbide
- Double ended for twice the life
- 76002** Blister packed 12 per pack



KEYRING

- Jiffy dart sharpener in handy rubberised keyring
- 76005** Blister packed 12 per pack

CHECKOUT® POCKET CARD

- Best ways to finish. Double sided
- 77000**
- Size 2 1/4" x 4 1/8" approx. (57mm x 105mm)



GOLDEN MATCH®

- The smallest darts in the world
- Pure 24 carat gold plated barrels
- 75500** 12 sets per pack



MAXI WALLET

- > Compact size disguises huge and versatile storage capacity
- > Convenient 3 sided zip fastening allows fold flat opening for easy access
- > 14 accessory pockets for spare shafts, flights and sundries
- > Velcro fastening inner pouch
- > Elasticated dart carrier
- > Holds a set of darts fully loaded
- > Velcro belt loop

NEW

46049 Unicorn
46156 Raymond van Barneveld
 3 cases per master carton

AUTOGRAPH COLLECTION

46125 Pink
46128 Autograph
46126 Fuchsia
 3 cases per master carton
 Darts and accessories not included



MIDI WALLET

- > Compact version of the best selling Maxi Case
- > Versatile and secure storage
- > Holds darts fully loaded
- > Specially designed compartments for flights and a full range of accessories

46090 3 cases per master carton
 Darts and accessories not included



MAESTRO® WALLET

- > Big capacity folding wallet with velcro closure
- > Contains 16 flight protectors, 2 sets of XL aluminium shafts, 1 set of XL shafts, Jiffy dart sharpener and 3 sets of flights
- > Complete with unique removable Unicorn pocket Dart Caddy

46098 3 cases per master carton

FLIP TOP WALLET

- > Stylish and convenient
- > Pockets for darts, flights and shafts

46081 12 wallets per master carton
 Darts and accessories not included



POCKET DART FOB

- > Convenient compact size
- > 3 compartments
- > 1 external flight/accessory compartment

46143 6 fobs per master carton



WOODEN DART CASE

- > Made from selected hardwoods
- > Traditional crushproof design
- > Holds darts with flights assembled
- > Polyurethane finish

46040 6 cases per master carton



CONTENDER XL HARD CASE

- › Total protection for your darts
- › Holds a set of darts fully loaded
- › Comprehensive storage for a complete range of spares and accessories
- › Special compartments for flights, shafts, tips and accessories
- › Detachable zipped pocket for spares
- › Detachable Unicorn pocket dart caddy

46139 3 cases per master carton



WALLETS & CASES

VERSATILE • STYLISH • TOTAL PROTECTION

CONTENDER HARD CASE

- › Total protection for your darts
- › Holds a set of darts fully loaded
- › Lots of storage for spares and accessories
- › Detachable zipped pocket for spares
- › Detachable Unicorn pocket dart caddy

46140 3 cases per master carton



3D WALLET

- › Tardis like capacity in 3 zipped compartments
- › Integral fittings to store darts, flights and shafts
- › Padded sections offer great protection
- › 3 sided zipped openings for easy access

46114 3 cases per master carton



FAJITA WALLET

- › It's hot! It's a wrap!
- › Convenient, compact and secure
- › Holds one set of darts
- › Compartments for flights shafts and accessories

46138 3 cases per master carton



Teknik Mens Dart Shirt



- > The cut and construction is specially designed to achieve maximum comfort and freedom of movement
- > The range has been developed in co-operation with Team Unicorn Players
- > Exclusive features are the unique side and under arm panels and expandable shoulder inserts which minimise movement restrictions
- > Lightweight 70% cotton 30% polyamide fabric
- > Colours - White/Black, Black/Gold, Blue/Black & Red/Black (see men's size chart below for measurements)



COLOURS	white/black	black/gold	blue/black	red/black
Small	801WBS	801BKS	801BS	801RBS
Medium	801WBM	801BKM	801BM	801RBM
Large	801WBL	801BKL	801BL	801RBL
X Large	801WBXL	801BKXL	801BXL	801RBXL
XX Large	801WBXXL	801BKXXL	801BXXL	801RBXXL
XXX Large	801WBXXXL	801BKXXXL	801BXXXL	801RBXXXL
XXXX Large	801WBXXXXL	801BKXXXXL	801BXXXXL	801RBXXXXL

Match Polo Shirt



- > Pique Polo shirt with comfortable knitted flat frame collar
- > Lightweight breathable 55% cotton 45% polyamide
- > Unique set-in side and underarm panels greatly improve comfort and freedom of movement in play
- > Unisex styling
- > Colours - White/Black, Black/Gold, Blue/Black & Red/Black (see men's size chart below for measurements)

COLOURS	white/black	black/gold	blue/black	red/black
Small	802WBS	802BKS	802BS	802RBS
Medium	802WBM	802BKM	802BM	802RBM
Large	802WBL	802BKL	802BL	802RBL
X Large	802WBXL	802BKXL	802BXL	802RBXL
XX Large	802WBXXL	802BKXXL	802BXXL	802RBXXL
XXX Large	802WBXXXL	802BKXXXL	802BXXXL	802RBXXXL
XXXX Large	802WBXXXXL	802BKXXXXL	802BXXXXL	802RBXXXXL

MENS SIZE	Small	Medium	Large	X Large	XX Large	XXX Large	XXXX Large
TO FIT CHEST	36" - 38"	39" - 41"	41" - 43"	43" - 46"	47" - 50"	50" - 53"	53" - 56"
JUNIOR SIZE	Black Small	Black Medium	Black Large				
TO FIT CHEST	33"	35"	37"				

Dart Shirt

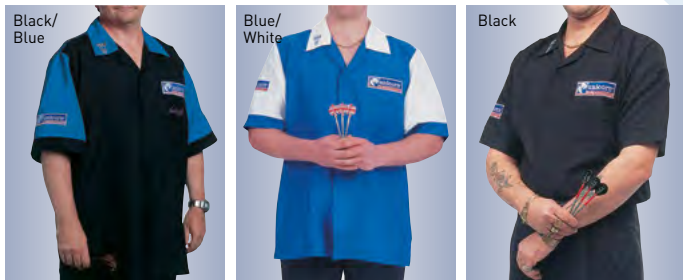

- > As worn by all 'Team Unicorn' players
 - > Colours - White/Black, Black/Blue Blue/White & Plain Black (**Plain Black available in Junior sizes**)
 - > 100% Polyester easy care fabric
- (see men's size chart on opposite page for measurements)

COLOURS	white/black	black/blue	blue/white	black
Small	800WBS	800BS	800WS	800BKS
Medium	800WBM	800BM	800WM	800BKM
Large	800WBL	800BL	800WL	800BKL
X Large	800WBXL	800BXL	800WXL	800BKXL
XX Large	800WBXXL	800BXXL	800WXXL	800BKXXL
XXX Large	800WBXXXL	800BXXXL	800WXXXL	800BKXXXL
XXXX Large	800WBXXXXL	800BXXXXL	800WXXXXL	800BKXXXXL

COLOURS	black junior
Small	800JBKS
Medium	800JBKM
Large	800JBKL
X Large	
XX Large	
XXX Large	

Teknik Ladies Dart Shirt



- > Designed and styled specially for ladies
- > The cut and construction give maximum comfort and freedom of movement
- > The range has been developed in co-operation with Team Unicorn Players
- > Lightweight 65% cotton 35% polyamide fabric
- > Colours - White/Black, Black/Gold, Blue/Black & Red/Black

COLOURS	white/black	black/gold	blue/black	red/black
Size 10	801LWB10	801LBK10	801LB10	801LRB10
Size 12	801LWB12	801LBK12	801LB12	801LRB12
Size 14	801LWB14	801LBK14	801LB14	801LRB14
Size 16	801LWB16	801LBK16	801LB16	801LRB16
Size 18	801LWB18	801LBK18	801LB18	801LRB18
Size 20	801LWB20	801LBK20	801LB20	801LRB20
Size 22	801LWB22	801LBK22	801LB22	801LRB22

LADIES SIZE	10	12	14	16	18	20	22
TO FIT BUST	34"-36"	36"-38"	38"-40"	40"-42"	42"-44"	44"-46"	46"-48"



85061
Sew-on Unicorn badge

POSTERS

POSTER SIZE 59.5cm x 42cm PORTRAIT or 42cm x 59.5cm LANDSCAPE

NEW

PLAYER STATISTICS

- 86671 Bob Anderson
- 86517 Anastasia Dobromyslova
- 86519 John Lowe
- 86516 Raymond van Barneveld

NEW

WORLD CHAMPIONS

- 86362 World Champions

MAESTRO PREMIER

- 86406 Maestro Premier

CONTENDER

- 86408 Contender



NEW

WAYS TO FINISH

- 86672 World Champion Ways To Finish



STICKERS / BADGES



- 86018 Window/Shelf Sticker 8cm x 30cm



- 85156 Self Adhesive Unicorn badge 2cm x 6cm

- 85061 Sew-on Unicorn Badge 4cm x 12cm



86405
FRED 2 Floor Standing Display Unit

- › Specifically designed to maximise the display capacity for Unicorn's 4 Dart pack formats in the 2013 range
- › Fully adjustable, it will still hold a comprehensive range of darts and accessories in all Unicorn packaging formats
- › In standard format it is supplied with provision for 3 rows of darts and 2 rows of accessories
- › Lockable dart display bars available to order
- › Additional standard and accessory bars available to order
- › Base has capacity for 8 dartboards
- › De-mountable promotional side display panels will be available on a periodic basis
- › Width at base 750mm Height 2000mm Depth at base 653mm (Side wing graphics plus 280mm x2)

86404
FRED 2 Wall Mounted /Counter Display Unit

- › Specifically designed to maximise the display capacity for Unicorn's 4 Dart pack formats in the 2013 range
- › Fully adjustable, it will still hold a comprehensive range of darts and accessories in all Unicorn packaging formats
- › In standard format it is supplied with provision for 2 rows of darts and 2 rows of accessories
- › Lockable dart display bars available to order
- › Additional standard and accessory bars available to order
- › Spot Light kits available to order
- › Free standing for counter display or can be wall hung
- › De-mountable promotional side display panels will be available on a periodic basis
- › Width 600mm Height 1000mm Depth 302mm (Side wings graphics plus 261mm x2)

86410
Security bar - fits any row
 (86405 and 86404 only)

86412
Accessory display bar
 (86405 and 86404 only)

NEW

86420
FRED 2 Slimline Floor Standing Display Unit.

- › All the features of 86405 but in a slimline unit.
- › Supplied with provision for 4 rows of darts and 2 rows of accessories.
- › Base has capacity for 7 dartboards
- › Width at base 500mm Height 2000mm Depth at base 560mm

86423
Accessory display bar - slim
 (86420 only)

85116
FRED Slat Wall Header



Universal FRED 2 Display Unit Items

86411
Standard hook

86421
Hook stop releaser

86422
Pack of 10 hook stops

TO OUR CUSTOMERS....

Our aim is to make trading with Unicorn easy.

We try very hard to have an appreciation of our customers' problems and to have a minimum of rules.

We feel the stating of our policies will make it easier and more profitable for our customers to deal with Unicorn.

1. WARNING

DARTS IS AN ADULT SPORT. IT IS DANGEROUS FOR CHILDREN TO PLAY WITHOUT SUPERVISION. WE RECOMMEND THAT A DEALER SHOULD EXERCISE DISCRETION WHERE ANY SALE MIGHT RESULT IN CHILDREN PLAYING WITHOUT ADULT SUPERVISION.

2. DISTRIBUTION

We are geared to supply goods to accredited retailers only and thus cannot give satisfaction to clubs or individuals, whom we refer to local dealers, anxious and ready to provide a prompt and complete service.

3. SPECIFICATIONS

We have taken every care to ensure that the information detailed in this catalogue is truthful and accurate. All weights and sizes are approximate and for guidance and comparison only. Should circumstances arising subsequent to publication render as unavoidable some changes in production, Unicorn Products Limited reserves absolute discretion to make these or any other changes they deem necessary without notice or obligation.

4. PRODUCT IMPROVEMENT

Continuous research and development will bring about changes in design, material and arrangement of our products during the life of this catalogue. We shall pass to our customers such benefits or improvements as they occur by delivering the latest version of any product. Such improvements or modifications as may be introduced do not place us under any obligation to make similar changes in articles sold before the date of introduction.

5. STANDARD PACKS

Many of the items in this catalogue are prepacked in convenient size standard packs. The standard pack has been selected for ease of stocking and ordering, economy in production and to ensure safe transit of the contents. For these reasons we cannot split standard packs and where orders call for other than standard packs we shall adjust the order to the nearest pack quantity.

6. GUARANTEE

It is our aim to ensure the complete satisfaction of our customers and in case of a genuine complaint as to the quality of our goods, we shall be anxious to rectify any fault of our own free will and at our discretion only.

7. IMITATIONS

The design, construction and trade names of most of our products are protected by patents, design registrations, trade marks, copyrights and/or pending applications and rigorous action will be taken against all infringers to protect both dealer and users from imitation.

8. ACCEPTANCE OF ORDER

All orders are accepted by us on the understanding that our Conditions of Sale as stated in our current price list form the basis of the Contract of Sale entered into by the placing and acceptance of such orders.



Unicorn Products Limited
Telephone: 0115 985 3500
Fax: 0115 985 3501
Email: assist@unicorngroup.com
Web: www.unicorn-darts.com

All returned goods must be sent to GM Operations Centre
Trent Lane, Colwick,
Nottingham NG2 4DS

© 2014 Unicorn Products Limited

The entire contents of this publication are the copyright of Unicorn Products Limited and may not be reprinted, copied or otherwise duplicated without written consent of the copyright owners

Catalogue designed by TGV, London
04148000 #85012

REFERENCE LINKS :

- 1 Unicorn Darts main website
<http://www.unicorn-darts.com/>



- 2 Unicorn - Heritage
<http://www.unicorn-darts.com/community/heritage/>



- 3 Team Unicorn
<http://www.unicorn-darts.com/team/>



- 4 UniLab
<http://www.unicorn-darts.com/unilab/>



- 5 UniScore
<http://uniscore.unicorn-darts.com/>



"There is hardly anything in the world that some man cannot make a little worse and sell a little cheaper, and the people who consider price only are this man's lawful prey."

John Ruskin