

BOOK OF DARTS

2016

40TH EDITION

www.unicorn-darts.com



unicorn[®]

THE BIG NAME IN DARTS[®]

GARY ANDERSON & UNICORN

#TheWinningDouble

7 REASONS WHY UNICORN?

This Unicorn Book of Darts is designed to assist our trade customers around the World with their purchasing decisions.

You should stock Unicorn because:

- 1 **UNDISPUTED** Unicorn design and engineering has powered more dart players to more World Titles than any other brand.
- 2 **NEW PRODUCT INNOVATION** Unicorn lead and have led for over 75 years.
- 3 **INVESTING** The PDC Unicorn Challenge Tour, The PDC Unicorn Youth Tour, The PDC Unicorn Youth World Championships creating aspirational opportunities for tomorrow's stars
- 4 **CHOICE OF THE PDC** For 20 years until at least 2017 every dart thrown live on SKY TV uses Unicorn Eclipse Pro & Eclipse HD dartboards.
- 5 **ON AIR** The Unicorn brand is exposed globally on TV for more than 5,000 hours each year, more than any other brand.
- 6 **RECOGNITION** Unicorn spend more money on Brand Promotion than all other companies put together.
- 7 **NAME** Since 1937, Unicorn – The Big Name In Darts.

These 7 reasons generate more demand for more profitable sales for the Unicorn brand from your customers than for any other dart brand.

IF YOU DON'T STOCK UNICORN, YOU ARE NOT IN THE DARTS BUSINESS.



NEW
FOR 2016

Core Transfer Technology

Twist DNA Super True Flights Mantis Mirage
Phase 5 Ultra Core PDL Purist
Koi World Champion Maestro Neon SoftFlex 360 Two tone
Evolution Series

THE UNICORN DART RANGE AT A GLANCE

PLAYER

THE ACTUAL PATTERNS
TEAM UNICORN USE

- STEEL TIP P4-13
- SOFT TIP P26-29

- WORLD CHAMPION 90% Tungsten
- MAESTRO PREMIER 97/90% Tungsten
- MAESTRO 90% Tungsten
- CONTENDER 90% Tungsten
- LEGEND 90% Tungsten
- GENERATION 180 90% Tungsten
- GLOBAL 90% Tungsten

PLAYER ENDORSED

AFFORDABLE
EXCELLENCE

- STEEL TIP P4-10
- SOFT TIP P26-29

- SILVER STAR 80% Tungsten
- BLACK STAR 80% Tungsten
- BULLET Stainless Steel
- BLACK Brass
- BARNEY Brass
- GOLD MEDAL Brass

INSIDE BACK PAGE KICKOUT: CROSS PLAYER DARTS

- SILVER STAR 80% Tungsten
- BLACK STAR 80% Tungsten
- BULLET Stainless Steel
- BLACK Brass

All player action shots in this Book of Darts are courtesy of the PDC whose co-operation we acknowledge with thanks.

Team Unicorn product development is a continuous process. The barrels illustrated are those in use by our players at the time of preparation of this Book of Darts.

U-TECH

CUTTING EDGE TECHNOLOGY.
PERFORMANCE ENHANCING

- STEEL TIP P14-21
- SOFT TIP P30-32

- SIGMA Carbon 95/90% Tungsten
- ULTRA CORE 80% Tungsten
- PHASE 5 95% Tungsten
- NEON 90% Tungsten
- LUMINA 90% Tungsten
- MACHINA 90% Tungsten
- GRIPPER CG 95% Tungsten
- GRIPPER 90% Tungsten
- MOGUL 80% Tungsten
- SPARKS 80% Tungsten
- AUTOGRAPH 80% Tungsten
- EVOLUTION SERIES 97-90% Tungsten
- SILVER COMET Brass
- MANTIS & B-FLY Soft tip only, 90% Tungsten
- KOI Soft tip only, 90% Tungsten

VALUE

PRECISION ENGINEERED.
NO NONSENSE VALUE

- STEEL TIP P22-25
- SOFT TIP P33-35

- CORE XL 95/90/80% Tungsten
- MIDAS Tungsten
- CORE PLUS Tungsten/Brass
- CORE Tungsten/Brass
- MASS MERCHANT RANGE

- DARTBOARDS & HDCs
- FLIGHTS
- SHAFTS
- ACCESSORIES
- WALLETS & CASES
- SHIRTS
- POSTERS
- IN-STORE DISPLAYS

- STEEL TIP version
- SOFT TIP version

BACK TO THIS DIRECTORY

#TheWinningDouble

January 4th 2015, Alexandra Palace, London

Gary Anderson hits Double 12 and with that dart Gary is Champion of The World.

At Unicorn we work with players to help design, engineer and manufacture the equipment they need to win. No drama, no bling, just trophies.

Our only focus is on #TheWinningDouble

**ECLIPSE PRO & ECLIPSE HD
DARTBOARDS PDC WORLD
RANKED No1**



WORLD CHAMPION

Gary Anderson	World Champion 2015
Raymond van Barneveld	5 Times World Champion
John Lowe	3 Times World Champion
Bob Anderson	World Champion

MAESTRO PREMIER

James Wade
Kim Huybrechts
Terry Jenkins
Wez Newton
Andy Hamilton

MAESTRO

Jamie Caven
Michael Smith - World Youth Champion

CONTENDER

Chris Aubrey
Ronny Huybrechts
Arron Monk - World Youth Champion
Joe Cullen
Dimitri Van den Bergh
Devon Petersen
Kyle Anderson
Keegan Brown - World Youth Champion

GENERATION 180

Adam Paxton	Andover Academy
Shane Reidy	Andover Academy
Samantha Pike	Andover Academy
Jack Warner	East Kent Academy
Dan Read	Andover Academy
Harriet Raynsford	Andover Academy
Jack Marriner	Petersfield Academy
Gavin Howard	Andover Academy

GLOBAL

Madars Razma	Latvia
Irina Armstrong	Russia
Barry Jouannet	Australia
Steffi Lück	Germany
Aden Kirk	England
Krzysztof Kciuk	Poland
Tomonori Takeda	Japan
Amit Gilitwala	India
Dirk van Duijvenbode	Netherlands
Tricia Wright	England
Michael Rosenauer	Germany
Nándor Bezzeg	Hungary
Boris Koltsov	Russia

TEAM UNICORN

THE PYRAMID OF EXCELLENCE





WORLD CHAMPION NATURAL 90% TUNGSTEN

- › Barrel designs as used by RvB on TV
- › Natural Tungsten
- › World Champion Aluminium shafts
- › Guaranteed Weight Certified $\pm 0.1g$
- › Premium wallet
- › Engraved Unicorn Hallmark



PHASE 1



- 10184** 21g
10185 23g
10186 25g Used by Raymond van Barneveld
10187 27g
- LP Finish**



PHASE 2



- 27341** 25g Used by Raymond van Barneveld

LP Finish



PHASE 2A natural/golden hybrid



- 27344** 25g Used by Raymond van Barneveld

LP Finish



PHASE 3

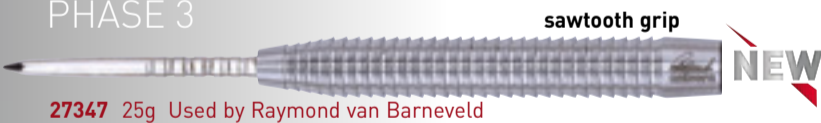

- 27347** 25g Used by Raymond van Barneveld

sawtooth grip



PHASE 4



- 27350** 23g Used by Raymond van Barneveld
27351 25g

LP Finish



PHASE 5 80% tungsten



- 11061** 21g Used by Raymond van Barneveld
11062 23g
11063 25g

PHASE 2 DNA

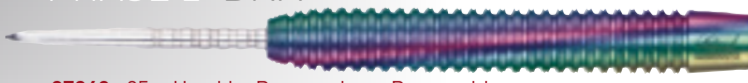

- 27260** 25g Used by Raymond van Barneveld

PURIST® PLAYER DEVELOPMENT LAB 90%/80% TUNGSTEN

- › Purist = Barrels only
- › Guaranteed Weight Certified $\pm 0.1g$
- › Purist wallet
- › Engraved Unicorn Hallmark



PURIST - BARRELS ONLY



SILVER STAR™ 80% TUNGSTEN

- › Natural Tungsten
- › Gripper shafts
- › Compact case
- › Engraved Unicorn Hallmark

- 07416 22g
- 07417 24g
- 07418 26g
- 07419 28g

[See inside back cover for full cross-player ranges]



BLACK STAR 80% TUNGSTEN

- › Black Titanium PVD non-slip grip
- › Gripper shafts
- › Compact case
- › Engraved Unicorn Hallmark

- 07196 24g
- 07197 26g

[See inside back cover for full cross-player ranges]



BULLET® STAINLESS STEEL

- › Super Durable Stainless Steel
- › XL Aluminium shafts
- › Compact case
- › Engraved Unicorn Hallmark

- 07547 21g
- 07548 23g
- 07549 25g

[See inside back cover for full cross-player ranges]



BLACK BRASS

- › Matt Black brass barrels
- › XL shafts
- › Compact case
- › Engraved Unicorn Hallmark

- 07715 22g
- 07716 24g
- 07717 26g

[See inside back cover for full cross-player ranges]

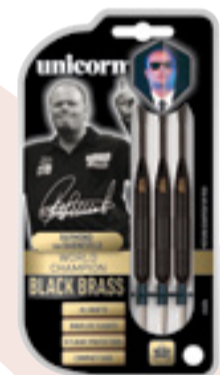

- 07805 21g
- 07806 23g
- 07807 25g
- 07808 27g

- 07811 21g
- 07812 23g
- 07813 25g
- 07814 27g

- 07817 21g
- 07818 23g
- 07819 25g
- 07820 27g

- 07823 21g
- 07824 23g
- 07825 25g

BARNEY BRASS

5 TIMES WORLD CHAMPION
RAYMOND van BARNEVELD ENDORSED

- › Colour coordinated
- › 100% brass barrels
- › Gripper shafts
- › Compact case



GARY ANDERSON

WORLD CHAMPION

STEEL TIP



WORLD CHAMPION NATURAL 90% TUNGSTEN

- › Barrel designs as used by Gary on TV
- › Natural Tungsten
- › World Champion Aluminium shafts
- › Guaranteed Weight Certified $\pm 0.1g$
- › Premium wallet
- › Engraved Unicorn Hallmark



PHASE 3

NEW

- 11066 21g
- 11067 23g Used by Gary Anderson
- 11068 25g
- 11069 27g



PHASE 1



NEW

- 27360 22g
- 27361 24g Used by Gary Anderson
- 27362 26g

PHASE 2



NEW

- 27365 22g
- 27366 24g Used by Gary Anderson

PHASE 3 DNA



- 27369 23g Used by Gary Anderson

PURIST® PLAYER DEVELOPMENT LAB 90% TUNGSTEN

- › Purist = Barrels only
- › Guaranteed Weight Certified $\pm 0.1g$
- › Purist wallet
- › Engraved Unicorn Hallmark

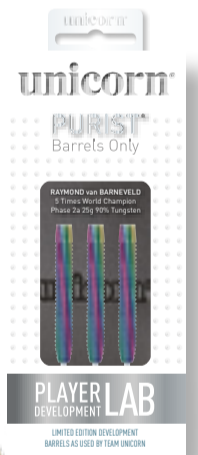

DNA FINISH BARRELS

- › DNA Titanium coating - each barrel unique



PURIST - BARRELS ONLY





SILVER STAR™ 80% TUNGSTEN

- › Natural Tungsten
- › Gripper shafts
- › Compact case
- › Engraved Unicorn Hallmark



- 08558 21g
- 08559 23g
- 08560 25g
- 08561 27g

[See inside back cover for full cross-player ranges]

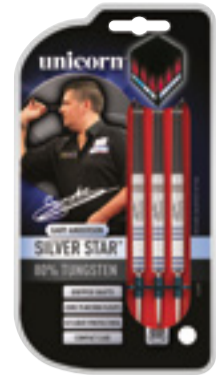

BLACK STAR 80% TUNGSTEN

- › Black Titanium PVD non-slip grip
- › Gripper shafts
- › Compact case
- › Engraved Unicorn Hallmark



- 27418 21g
- 27419 23g
- 27420 25g

[See inside back cover for full cross-player ranges]



BULLET® STAINLESS STEEL

- › Super Durable Stainless Steel
- › XL Aluminium shafts
- › Compact case
- › Engraved Unicorn Hallmark



- 27326 22g
- 27327 24g
- 27328 26g

[See inside back cover for full cross-player ranges]



BLACK BRASS

- › Matt Black brass barrels
- › XL shafts
- › Compact case
- › Engraved Unicorn Hallmark



- 27331 23g
- 27332 25g
- 27333 27g

[See inside back cover for full cross-player ranges]

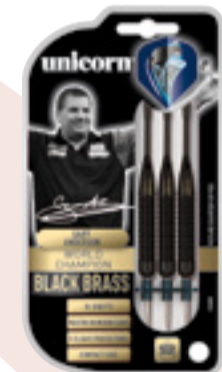

- 27401 22g
- 27404 24g
- 27406 26g
- 27407 27g
- 27409 29g

GARY ANDERSON GOLD MEDAL BRASS

- › 100% brass barrels
- › Gripper shafts
- › Compact case
- › Comprehensive weight and pattern range





WORLD CHAMPION NATURAL 90% TUNGSTEN

- › Barrel designs as used by John or Bob on TV
- › Natural Tungsten
- › World Champion Aluminium shafts
- › Guaranteed Weight Certified $\pm 0.1g$
- › Premium wallet
- › Engraved Unicorn Hallmark



- 10162** 21g Used by John Lowe
- 10163** 23g
- 10164** 25g
- 10165** 27g



- 10179** 20g Used by Bob Anderson
- 10180** 22g
- 10181** 24g



PURIST - BARRELS ONLY

JOHN LOWE GOLDEN



- 27339** 21g Used by John Lowe

NEW

JOHN LOWE DNA



- 27262** 21g Used by John Lowe

PURIST® PLAYER DEVELOPMENT LAB 90% TUNGSTEN

- › Purist = Barrels only
- › Guaranteed Weight Certified $\pm 0.1g$
- › Purist wallet
- › Engraved Unicorn Hallmark

DNA FINISH BARRELS

- › DNA Titanium coating - each barrel unique

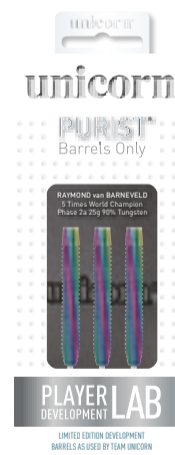

BULLET® STAINLESS STEEL

JOHN LOWE



- 07291** 21g
- 07292** 23g
- 07293** 25g

- › Super Durable Stainless Steel
- › XL Aluminium shafts
- › Compact case
- › Engraved Unicorn Hallmark



[See inside back cover for full cross-player ranges]

JAMES WADE PHASE 2



- 11030 20g Used by James Wade
- 11031 22g
- 11032 24g

KIM HUYBRECHTS



- 11072 22g
- 11073 24g Used by Kim Huybrechts
- 11074 26g

WEZ NEWTON



- 11026 22g Used by Wez Newton
- 11027 24g

ANDY HAMILTON 97% TUNGSTEN



- 10385 23g
- 10386 25g Used by Andy Hamilton
- 10387 27g

TERRY JENKINS



- 10272 21g Used by Terry Jenkins
- 10273 23g
- 10274 25g

MAESTRO® PREMIER NATURAL
97/90% TUNGSTEN

- › Barrel designs as used by Maestro Premiers on TV
- › Natural Tungsten
- › Aluminium shafts
- › Guaranteed Weight Certified $\pm 0.1g$
- › Premium wallet
- › Engraved Unicorn Hallmark



JAMES WADE PHASE 1



- 27371 20g Used by James Wade
- 27372 22g
- 27373 24g

JAMES WADE PHASE 2 DNA



- 27266 20g Used by James Wade

KIM HUYBRECHTS DNA



- 27416 24g Used by Kim Huybrechts

WEZ NEWTON GOLDEN



- 27357 22g Used by Wez Newton

WEZ NEWTON DNA

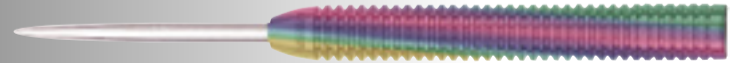

- 27276 22g Used by Wez Newton

PURIST® PLAYER DEVELOPMENT LAB
97/90% TUNGSTEN

- › Purist = Barrels only
- › Guaranteed Weight Certified $\pm 0.1g$
- › Purist wallet
- › Engraved Unicorn Hallmark

DNA FINISH BARRELS

- › DNA Titanium coating - each barrel unique

ANDY HAMILTON GOLDEN



- 27354 25g Used by Andy Hamilton (97% Tungsten)

ANDY HAMILTON DNA



- 27274 25g Used by Andy Hamilton (97% Tungsten)

TERRY JENKINS DNA



- 27270 21g Used by Terry Jenkins

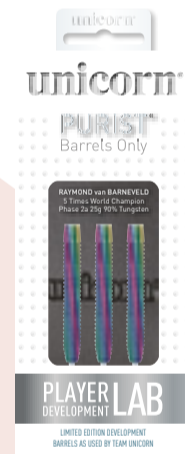

PURIST - BARRELS ONLY

SILVER STAR™
80% TUNGSTEN

- 08563 22g
- 08564 24g
- 08565 26g
- 08566 28g

JAMES WADE



KIM HUYBRECHTS



- › Natural Tungsten
- › Gripper shafts
- › Compact case
- › Engraved Unicorn Hallmark

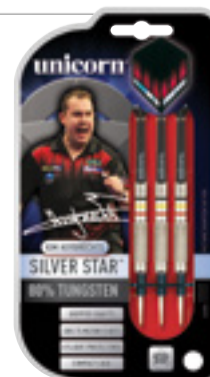

[See inside back cover for full cross-player ranges]

MAESTRO

MICHAEL SMITH AND JAMIE CAVEN

STEEL TIP

MAESTRO® NATURAL 90% TUNGSTEN

- › Barrel designs as used by Maestros on TV
- › Natural Tungsten
- › Gripper shafts
- › Guaranteed Weight Certified $\pm 0.1g$
- › Engraved Unicorn Hallmark

NEW

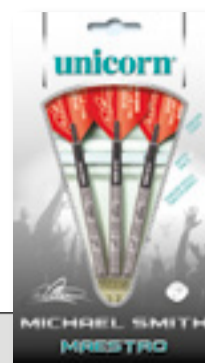

› Environmentally friendly inner packaging made from 100% recycled material.

MICHAEL SMITH



10686 22g Used by Michael Smith
10687 24g

JAMIE CAVEN



10681 23g Used by Jamie Caven
10682 25g

NEW

NEW

PURIST - BARRELS ONLY

MICHAEL SMITH DNA



27414 22g Used by Michael Smith

JAMIE CAVEN DNA



27412 23g Used by Jamie Caven

PURIST® PLAYER DEVELOPMENT LAB 90% TUNGSTEN

- › Purist = Barrels only
- › Guaranteed Weight Certified $\pm 0.1g$
- › Purist wallet
- › Engraved Unicorn Hallmark

DNA FINISH BARRELS

- › DNA Titanium coating - each barrel unique



SILVER STAR™ 80% TUNGSTEN



- › Natural Tungsten
- › Gripper shafts
- › Compact case
- › Engraved Unicorn Hallmark

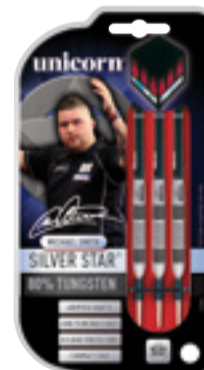

NEW

27308 22g
27309 24g
27310 26g
27311 28g
27312 30g

[See inside back cover for full cross-player ranges]

LEGEND

BARRY TWOMLOW

PURIST - BARRELS ONLY

BARRY TWOMLOW



27385 22g
27386 24g

NEW

Barry Twomlow

News Of The World Champion
"The Man Who Taught
The World To Play Darts"

PURIST® PLAYER DEVELOPMENT LAB 90% TUNGSTEN

- › Purist = Barrels only
- › Guaranteed Weight Certified $\pm 0.1g$
- › Purist wallet
- › Engraved Unicorn Hallmark



CONTENDER

RISING STARS IN THE PDC RANKINGS

STEEL TIP



DEVON PETERSEN

NEW

11080 22g



JOE CULLEN

NEW

11082 21g



KEEGAN BROWN

NEW

11077 22g



KYLE ANDERSON

NEW

11086 23g



DIMITRI VAN DEN BERGH

NEW

11088 22g



RONNY HUYBRECHTS

10335 23g (95% Tungsten)



ARRON MONK

10388 22g



CHRIS AUBREY

10316 21g

CONTENDER 95/90% TUNGSTEN

- › Barrel designs as used by Contenders on TV
- › Gripper shafts
- › Guaranteed Weight Certified $\pm 0.1g$
- › Compact case
- › Engraved Unicorn Hallmark



PURIST - BARRELS ONLY



DEVON PETERSEN BLACK

27380 22g

NEW



JOE CULLEN GOLDEN

27382 21g

NEW



KEEGAN BROWN GOLDEN

27376 22g

NEW



KYLE ANDERSON GOLDEN

27391 23g

NEW

PURIST® PLAYER DEVELOPMENT LAB 90% TUNGSTEN

- › Purist = Barrels only
- › Black or Golden Titanium PVD non-slip grip finishes as used by players
- › Guaranteed Weight Certified $\pm 0.1g$
- › Purist wallet
- › Engraved Unicorn Hallmark

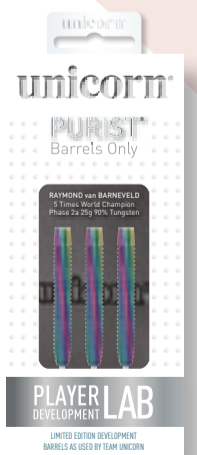

NEW

ADAM PAXTON



07561 23g

NEW

SHANE REIDY



07566 25g (95% Tungsten)

HARRIET RAYNSFORD



07574 19g

GAVIN HOWARD



07551 24g

JACK MARRINER



07538 24g

JACK WARNER



07511 23g

SAMANTHA PIKE



07541 29g

DAN READ



07530 26g



GENERATION 180
95/90% TUNGSTEN

Younger players rising through the ranks from Unicorn's partnership with Dart Academies
 › Reinvesting in Youth Darts by sponsoring the PDC Unicorn Youth Tour & PDC Unicorn World Youth Championships through to 2017

- › Promoting today for tomorrow's sales
- › Gripper shafts
- › Guaranteed Weight Certified $\pm 0.1g$
- › Compact case
- › Engraved Unicorn Hallmark



Unicorn is proud to be a partner of the Andover Academy, Petersfield Academy, Ashford Academy, East Kent Darts Academy and Jamie Caven Darts Academy.

NEW

BORIS KOLTSOV



10743 21g (95% Tungsten)

NEW

AMIT GILITWALA



10733 24g (80% Tungsten)

NEW

ADEN KIRK

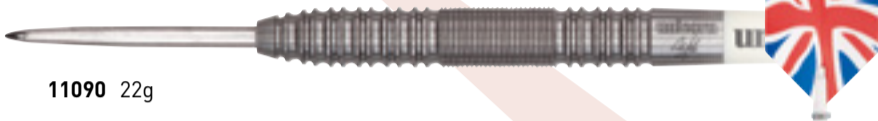

11090 22g

NEW

IRINA ARMSTRONG



11084 23g

MADARS RAZMA



10675 25g (95% Tungsten)

DIRK VAN DUIJVENBODE



10741 21g (80% Tungsten)

STEFFI LÜCK



10662 23g

KRZYSZTOF KCIUK



10670 20g

TRICIA WRIGHT



10758 29g

GLOBAL

95/90/80% TUNGSTEN

- › Reflecting Unicorn's International reach and Global consumer demand
- › Gripper shafts
- › Guaranteed Weight Certified $\pm 0.1g$
- › Compact case
- › Engraved Unicorn Hallmark



NANDOR BEZZEG

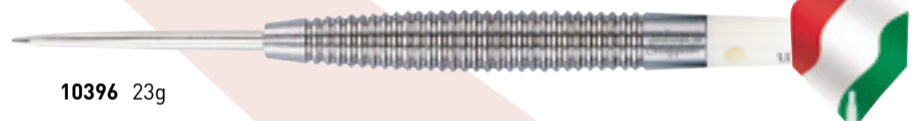

10396 23g

MICHAEL ROSENAUER

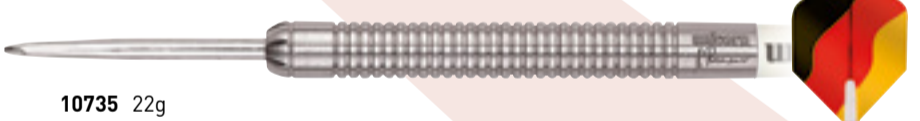

10735 22g

TOMONORI TAKEDA



10752 20g

BARRY JOUANNET

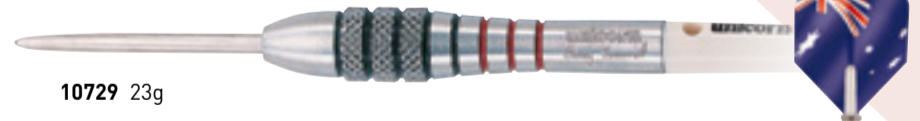

10729 23g

PURIST - BARRELS ONLY

IRINA ARMSTRONG BLACK



27389 23g Used by Irina Armstrong

NEW

ADEN KIRK GOLDEN



27393 22g Used by Aden Kirk

NEW

PURIST® PLAYER DEVELOPMENT LAB

90% TUNGSTEN

- › Purist = Barrels only
- › Black or Golden Titanium PVD non-slip grip finishes as used by players
- › Guaranteed Weight Certified $\pm 0.1g$
- › Purist wallet
- › Engraved Unicorn Hallmark



SIGMA™ SUPER PRO CARBON

95% TUNGSTEN TUNED FOR BEST ACCURACY



10665 21g
10666 23g
10667 25g

- > Sigma certified use of Carbon Fibre material for compelling strength:weight ratio
- > Screw In Sigma ZeroD Carbon Nose Cones: 3 x 25mm & 3 x 25mm finger grip
- > Sigma Super Pro 100% Carbon Fibre shafts
- > Sigma Super Pro ultra compact delta flights
- > Sigma Carbon Premium Wallet



SIGMA™ XL SUPER PRO

95% TUNGSTEN TUNED FOR BEST ACCURACY



10363 21g
10364 23g
10365 25g

- > Unforgiving performance, recommended for a player at the peak of his game
- > Screw In Titanium Zero Deflection Nose Cones: 3 x 25mm & 3 x 25mm finger grip
- > Sigma Super Pro 100% Magnesium shafts
- > Sigma Super Pro ultra compact delta flights
- > Sigma Premium wallet

SIGMA™ XL PRO

95% TUNGSTEN TUNED FOR BETTER ACCURACY



10375 21g
10376 23g
10377 25g

- > Screw In Titanium Zero Deflection Nose Cones: 3 x 28mm & 3 x 28mm finger grip
- > Sigma Pro Magnesium side-load shafts
- > Sigma Pro compact delta flights
- > Sigma Premium wallet

SIGMA™ X CROSS TIP

95% TUNGSTEN TUNED FOR ACCURACY

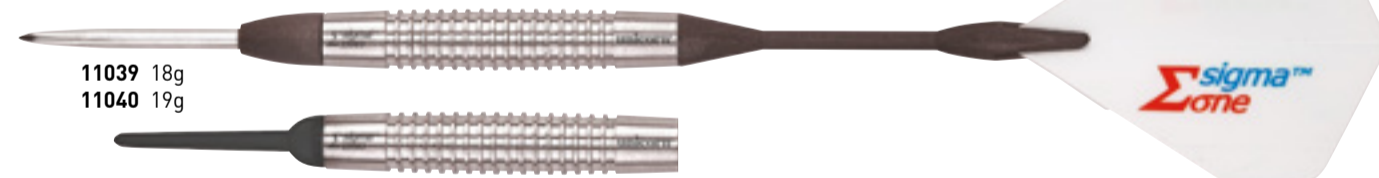

11039 18g
11040 19g

Soft tip configuration

- > Sigma Super Pro Carbon shafts
- > Set of black Teknik tips x 6
- > Sigma One white flights
- > Set of 3 Sigma ZeroD CR Nosecones - 28mm
- > Sigma wallet
- > Assembled as steel tip in the case

Sigma X Cross Tip are Sigma certified in both steel tip and soft tip configurations. In both configurations the darts weigh the same - eg 18g Sigma X - when configured as the Steel Tip pointed barrel is 18g, when configured as the Soft Tip the all up weight is 18g. This allows the Cross Code player to always use the same barrels and weight.

SIGMA™ X CROSS TIP CHAMPIONSHIP

95% TUNGSTEN TUNED FOR ACCURACY



11043 21g
11044 23g

Soft tip configuration

- > Sigma CR shafts
- > Set of black Teknik tips x 6
- > Sigma One black flights
- > Set of 3 Sigma ZeroD Titanium Nosecones - 28mm
- > Sigma wallet
- > Assembled as steel tip in the case



All Sigma darts are designed as integrated aerodynamic units optimised for Accuracy (Pro) or Stability (One).

See more about Sigma at www.unicorn-darts.com/range/darts-sigma.aspx



SIGMA™ PRO 970

97% TUNGSTEN TUNED FOR ACCURACY

GOLDEN



- 10946 21g
- 10947 23g
- 10948 25g
- 10949 27g

NATURAL



- 10901 21g
- 10902 23g
- 10903 25g
- 10904 27g

NATURAL LP finish



- 11048 23g
- 11049 25g

- › Available in Natural Tungsten or Golden Titanium PVD for non-slip grip
- › Sigma Pro Titanium side-load shafts
- › Sigma Pro compact delta flights
- › Sigma Premium wallet

SIGMA™ PRO 950

95% TUNGSTEN TUNED FOR ACCURACY

GOLDEN



- 10954 22g
- 10955 24g

COARSE GRIP

NATURAL



- 10960 18g
- 10961 20g
- 10962 22g
- 10963 24g
- 10964 26g

COARSE GRIP

- › Available in Natural Tungsten or Golden Titanium PVD for non-slip grip
- › Sigma Pro Titanium side-load shafts
- › Sigma Pro compact delta flights
- › Sigma Premium wallet

SIGMA™ 4 PRO

95% TUNGSTEN TUNED FOR ACCURACY



- 10398 20g
- 10399 22g
- 10400 24g

FORWARD WEIGHTED

- › Screw In Titanium Zero Deflection Nose Cones
- › 25mm finger grip
- › Sigma Pro Titanium side-load shafts
- › Sigma Pro compact delta flights
- › Sigma Premium wallet

SIGMA™ ONE 970

97% TUNGSTEN TUNED FOR STABILITY



- 10907 21g
- 10908 23g
- 10909 25g
- 10910 27g

SOFT TIP

OPTIMISED FOR SOFT TIP BOARDS

- › Sigma One rigid shafts
- › Sigma One enhanced delta flights
- › Sigma Premium wallet

- 03594 19g

SIGMA™ ONE 950

95% TUNGSTEN TUNED FOR STABILITY

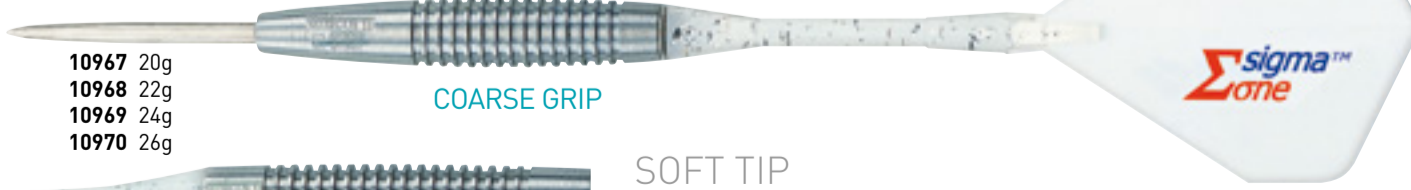

- 10967 20g
- 10968 22g
- 10969 24g
- 10970 26g

COARSE GRIP

SOFT TIP

OPTIMISED FOR SOFT TIP BOARDS

- › Sigma One rigid shafts
- › Sigma One enhanced delta flights
- › Sigma Premium wallet

- 03595 18g

COARSE GRIP

NEW

ULTRACORE™ ONE 80% TUNGSTEN

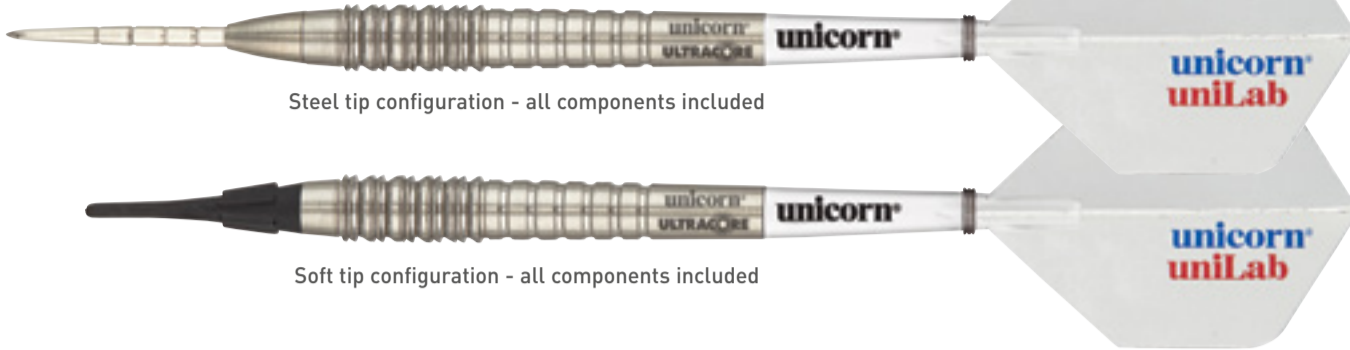

05118
ULTRACORE ONE
can be configured
with all-up weight
from 17g-26g
ALL COMPONENTS
INCLUDED

- › Ergonomic grip positions
- › Aerodynamic barrel profile
- › Converts from steel tip to soft tip
- › Unicorn Certified Tungsten Nickel Alloy
- › UniLab plus shape flights
- › Gripper 3 Mirage shafts
- › 12 x 2g 97% Tungsten inserts
- › 12 x .25g Polymer inserts
- › 3 x Checkout finger grip soft tips
- › 3 x Sigma ZeroD Titanium nose cones

The UniBoffin says:

"Tuning darts for optimal aerodynamics can help scoring, but tuning for optimal ergonomics may be the crucial difference. Configured to play either Steel-tip or Soft-tip and utilising CTT (Core Transfer Technology) ULTRACORE enables you to successfully change the definition of your darts.

With 16 different combinations of weight and balance to suit your particular grip position and throwing technique the search for your perfect dart could end here!"

$$\Delta M = \sum_{i=1,n} m_i$$

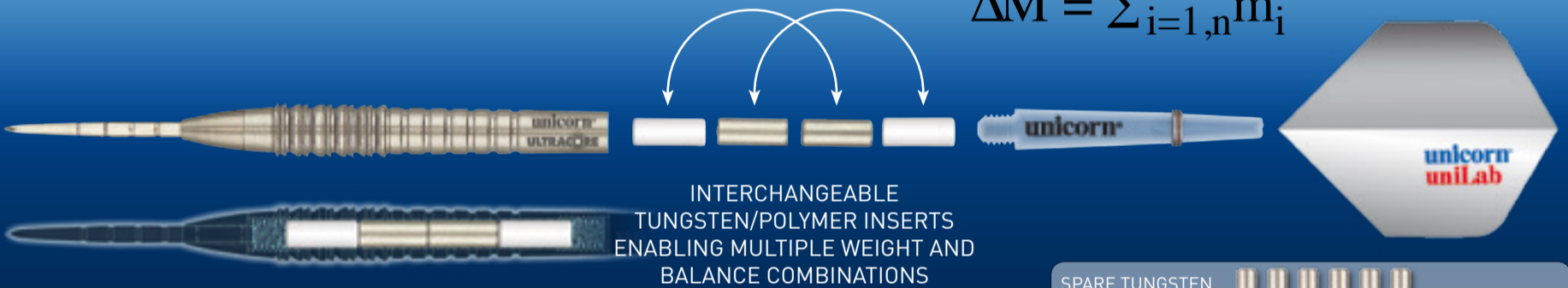

SPARE TUNGSTEN
OR POLYMER
INSERTS
6 inserts per card,
12 cards per pack



78063 TUNGSTEN

78062 POLYMER



PHASE 5 MIRAGE 95% TUNGSTEN

- › 1 set of guaranteed weight matched 95% Tungsten barrels
- › 1 set of Phase 5 Mirage DXM flights
- › 1 set of Gripper Mirage shafts
- › 1 Purist wallet
- › Milled aluminium trident



NEW

NEON™
90% TUNGSTEN

05113 22g
05114 24g
05115 26g

- › Shark tooth nose for controlled release
- › Complex machina rear grip
- › Aerodynamic barrel profile
- › DNA titanium coating - each barrel unique
- › Gripper 3 Mirage shafts
- › Neon Core .75 flights
- › Milled aluminium trident

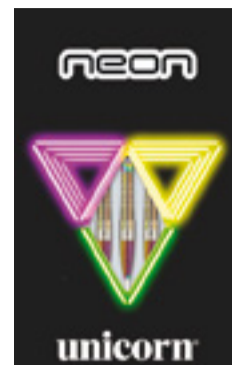
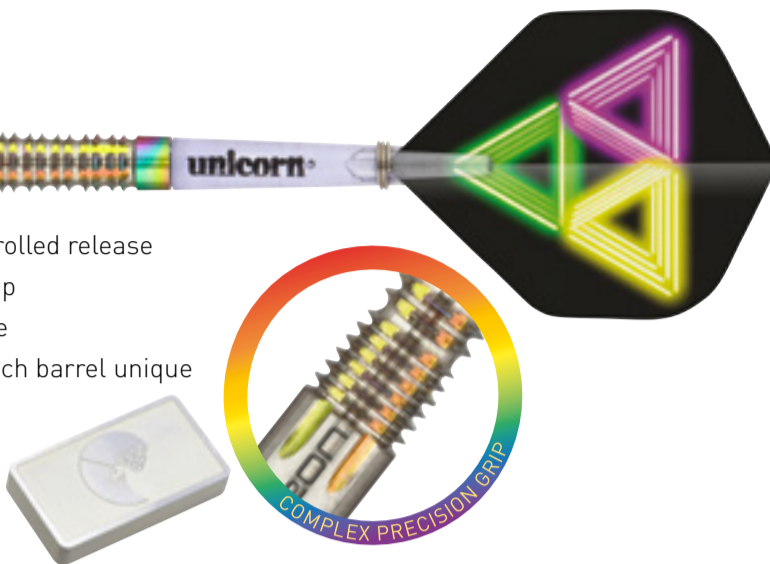

LUMINA™
90% TUNGSTEN

05095 21g
05096 23g
05097 25g

- › Shark toothed barrel - outstanding grip
- › Aerodynamic bullet barrel profile
- › Finger grip points for total control
- › 90% Unicorn Certified Tungsten Nickel Alloy
- › XL 100% Titanium DNA shafts
- › Q .100 micron fin flights
- › Premium wallet



LUMINA™ DNA
90% TUNGSTEN

05100 21g
05101 23g
05102 25g

- › Shark toothed barrel - outstanding grip
- › DNA titanium coating - each barrel unique
- › Finger grip points for total control
- › 90% Unicorn Certified Tungsten Nickel Alloy
- › XL 100% Titanium DNA shafts
- › Q .100 micron fin flights
- › Premium wallet



MACHINA™ GOLD
90% TUNGSTEN

05085 21g
05086 23g
05087 25g

- › Golden Titanium PVD non-slip surface
- › Complex precision grip
- › Machina aluminium shafts
- › Maestro 100 micron pro-grade flights
- › Premium wallet



MACHINA™ BLACK
90% TUNGSTEN

05090 22g
05091 24g
05092 26g

- › BlackTitanium PVD non-slip surface
- › Complex precision grip
- › Machina aluminium shafts
- › Maestro 100 micron pro-grade flights
- › Premium wallet





GRIPPER CG
95% TUNGSTEN/MAGNESIUM

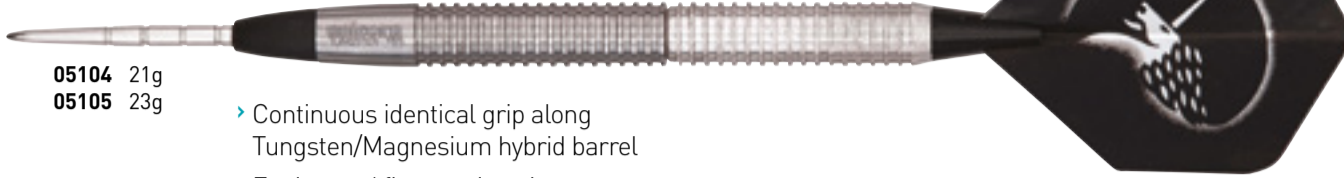

05104 21g
05105 23g

- › Continuous identical grip along Tungsten/Magnesium hybrid barrel
- › Engineered finger grip points
- › Replaceable Sigma ZeroD Carbon reinforced nose cones
- › Guaranteed Weight Certified $\pm 0.1g$
- › Compact case
- › Engraved Unicorn Hallmark

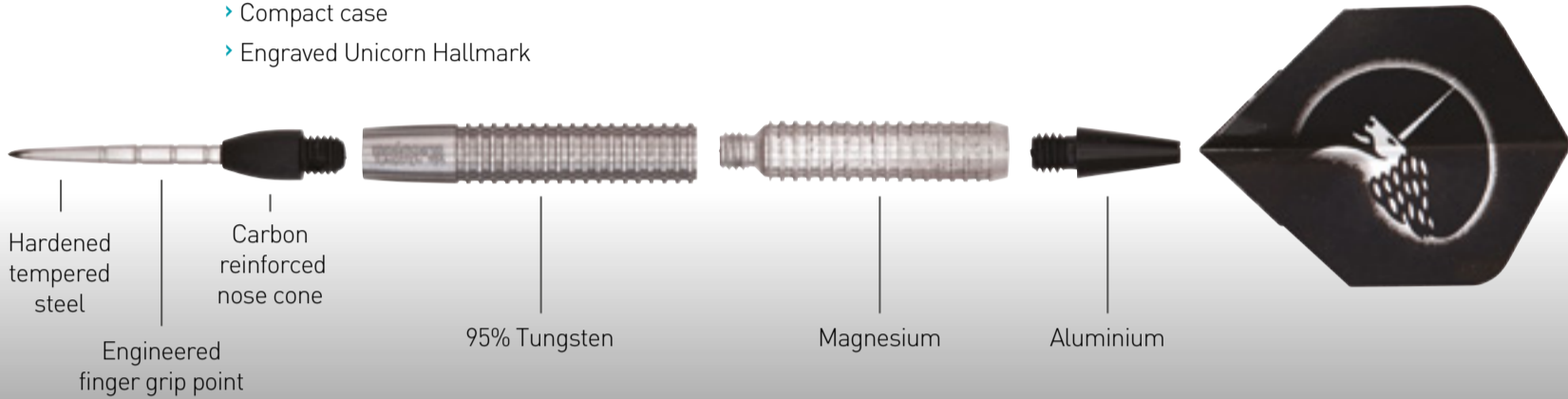

GRIPPER® CG

A whole new way of thinking.

Continuous grip, constant diameter using a two piece Tungsten Magnesium hybrid barrel!

CAD optimised hybrid combination of the right materials in the right place for outstanding balance and superb flight dynamics.

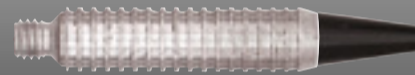

CG HYBRID
FLIGHT HOLDER

- › Fits all Unicorn dart barrels but designed to be used specifically with Gripper CG

78211 3 holders per card, 12 cards per pack



GORDON SHUMWAY



05051 22g
05052 24g
05053 26g Used By Gordon Shumway

GRIPPER®
90% TUNGSTEN



05027 21g
05028 23g
05029 25g

- › Aggressive and individual barrel grips
- › Engineered finger grip points
- › Gripper 360 rotating shafts
- › Compact case
- › Engraved Unicorn Hallmark



05032 20g
05033 22g
05034 24g



05047 23g
05048 25g



07873 22g
07874 24g
07875 26g

MOGUL 1

Aero golfball grip



07878 21g
07879 23g
07880 25g

MOGUL 2



07883 22g
07884 24g
07885 26g

MOGUL 3

MOGUL™ 80% TUNGSTEN

- › Innovative manufacturing process creates barrel grips that are not possible with traditional machining
- › Gripper 3 shafts
- › Core 75 micron flights
- › Compact case
- › Engraved Unicorn Hallmark



07671 22g
07672 24g
07673 26g

07667 22g
07668 24g
07669 26g

SPARKS™ 80% TUNGSTEN

- › Colour coordinated total presentation
- › XL Aluminium shafts
- › Compact case
- › Engraved Unicorn Hallmark



05850 22g
05851 24g
05852 26g
05853 28g



05855 23g
05856 25g
05857 27g
05858 29g

AUTOGRAPH® 80% TUNGSTEN

- › Configured by and for lady players
 - › Subtle total coordination
 - › Gripper shafts
 - › White Compact case
 - › Fully coordinated accessories available
- FOR REAL STYLE ON THE OCHE!



Autograph
collection

EVOLUTION SERIES

TRACKS THE UNICORN DARTS USED BY PHIL TAYLOR IN HIS UNICORN YEARS

STEEL TIP

PURIST - BARRELS ONLY



27285 24g

NEW

PHASE 1
PURIST®
90% TUNGSTEN

NEW

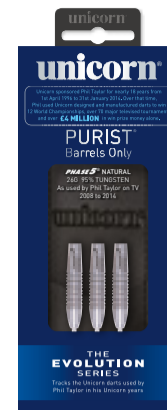

27286 24g

NEW

- › Purist = Barrels Only
- › As used on TV 1996 to 1999
- › Guaranteed Weight Certified $\pm 0.1g$
- › Purist wallet
- › Engraved Unicorn Hallmark



27287 24g

NEW



27290 24g

NEW

PHASE 2
PURIST®
90% TUNGSTEN

- › Purist = Barrels Only
- › As used on TV 1999 to 2007
- › Guaranteed Weight Certified $\pm 0.1g$
- › Purist wallet
- › Engraved Unicorn Hallmark



27291 24g

NEW

Approximate PDC Major Tournament winnings over £900,000



27294 24g

NEW

PHASE 3
PURIST® CURVE
90% TUNGSTEN

- › Purist = Barrels Only
- › As used on TV 2003
- › Guaranteed Weight Certified $\pm 0.1g$
- › Purist wallet
- › Engraved Unicorn Hallmark



27295 24g

NEW



27298 26g

NEW

PHASE 5
PURIST®
95% TUNGSTEN

- › Purist = Barrels Only
- › As used on TV since 2008
- › Guaranteed Weight Certified $\pm 0.1g$
- › Purist wallet
- › Engraved Unicorn Hallmark



27299 26g

NEW



27301 26g

NEW

PHASE 5 LP
PURIST®
95% TUNGSTEN

- › Purist = Barrels Only
- › As used on TV 2013
- › Guaranteed Weight Certified $\pm 0.1g$
- › Purist wallet
- › Engraved Unicorn Hallmark



27304 25g

NEW

PHASE 6
PURIST®
97% TUNGSTEN

- › Purist = Barrels Only
- › As used on TV 2011
- › Guaranteed Weight Certified $\pm 0.1g$
- › Purist wallet
- › Engraved Unicorn Hallmark



27305 25g

NEW

PHASE 5 95% TUNGSTEN

ROSSO



27336 26g

NEW



Approximate PDC Major Tournament winnings over £2.8m

- › As used on TV since 2008
- › Phase 5 Titanium side load shafts with replaceable tops
- › Guaranteed Weight Certified $\pm 0.1g$
- › Slimline wallet
- › Engraved Unicorn Hallmark

All Phase 5 darts are supplied complete with an additional set of DXM flights



Unicorn sponsored Phil Taylor for nearly 18 years from 1st April 1996 to 31st January 2014. Over that time, Phil used Unicorn designed and manufactured darts to win 12 World Championships, over 70 major televised tournaments and over £4 million in win prize money alone.



HERITAGE RANGE

PRICELESS REPLICAS

The Unicorn Heritage range showcases landmark Unicorn design, products & innovation since the Company was founded by Frank Lowy in the 1930's.



Every model in the Unicorn Heritage range is a priceless replica of historic Unicorn engineering and will continue to interest, fascinate and delight collectors, connoisseurs and enthusiasts alike.

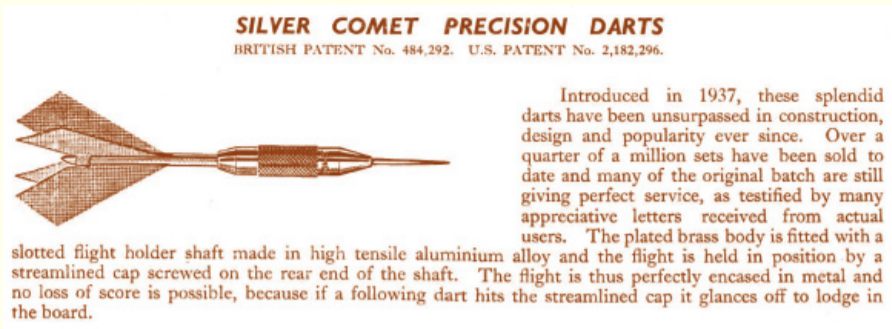

Reproduced from the First Edition of the Unicorn Book of Darts



1937 SILVER COMET®

- › Plated brass barrels
- › Slotted flight holder
- › Aluminium alloy shafts
- › Patented screw shaft cap
- › Comet fibreboard flights
- › Replica presentation box



Replica presentation box



07100 Medium

78608 Comet replacement shafts (dozen sets)

68502 Comet replacement flights (dozen sets)

SUPER VALUE BONUS PACK
ALL CORE XL MODELS

Comprising:

- › 2 sets of Gripper shafts,
- › 2 sets of polyester flights,
- › 8 flight protectors,
- › 6 spare Gripper rings,
- › 1 Checkout Chart



ALL
CORE XL
MODELS

Contents
may vary



- › Slimline case
- › Ultra slim
- › Durable



CORE XL T95
95% TUNGSTEN

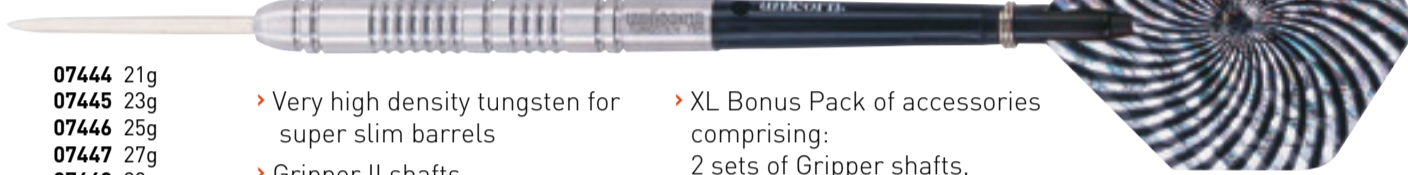

- 07444 21g
- 07445 23g
- 07446 25g
- 07447 27g
- 07448 29g

- › Very high density tungsten for super slim barrels
- › Gripper II shafts
- › Slimline case
- › Engraved Unicorn Hallmark
- › XL Bonus Pack of accessories comprising:
2 sets of Gripper shafts,
2 sets of polyester flights,
8 flight protectors,
6 spare Gripper rings,
1 Checkout Chart



- 07397 23g
- 07398 25g
- 07399 27g
- 07400 29g



- 07859 22g
- 07860 24g
- 07861 26g



- 07378 23g
- 07379 25g

CORE XL T90
90% TUNGSTEN

- › Range of precision engineered barrels
- › Gripper II shafts
- › Slimline case
- › Engraved Unicorn Hallmark
- › XL Bonus Pack of accessories comprising:
2 sets of Gripper shafts,
2 sets of polyester flights,
8 flight protectors,
6 spare Gripper rings,
1 Checkout Chart



- 05059 22g
- 05060 24g
- 05061 29g
- 05062 36g



- 05079 21g
- 05080 23g
- 05081 25g
- 05082 27g

CORE XL T80
80% TUNGSTEN

- › Great value enhanced Tungsten range
- › Gripper II shafts
- › Slimline case
- › Engraved Unicorn Hallmark
- › XL Bonus Pack of accessories comprising:
2 sets of Gripper shafts,
2 sets of polyester flights,
8 flight protectors,
6 spare Gripper rings,
1 Checkout Chart





CORE XL STRIKER®
80% TUNGSTEN



05016 29g



05001 18g



05003 20g



05004 21g



05005 22g



05006 23g



05008 24g



05011 25g



05012 26g



05014 27g



05015 28g

- > Huge range of budget Tungsten dart sets
- > Gripper II shafts
- > Slimline case
- > XL Bonus Pack of accessories comprising:
2 sets of Gripper shafts,
2 sets of polyester flights,
8 flight protectors,
6 spare Gripper rings,
1 Checkout Chart



05016 29g



05017 30g



05019 32g



05021 34g



05022 36g



05023 38g



05024 40g

MIDAS™

TUNGSTEN
UNICORN BIN ENDS!

From time to time we end up with end of lines, now available for the first time through our Midas programme.

All Midas darts use 100% genuine Unicorn manufactured components made entirely in our own factories and offer incredible value for money.

Midas are available in Natural Tungsten and Titanium Tungsten, contact the Unicorn Sales Office assist@unicorngroup.com to check current availability.



CORE PLUS
TUNGSTEN

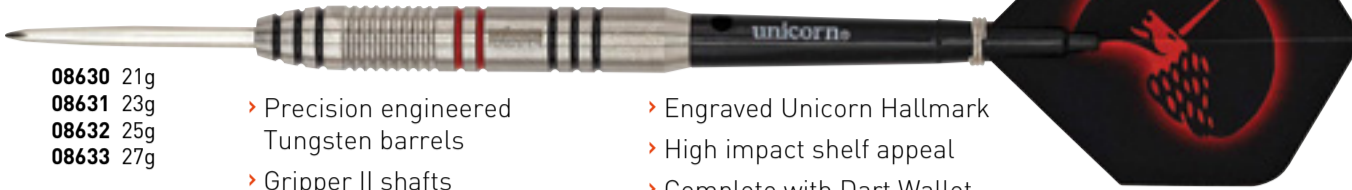

08630 21g
08631 23g
08632 25g
08633 27g

- > Precision engineered Tungsten barrels
- > Gripper II shafts
- > Compact footprint
- > Engraved Unicorn Hallmark
- > High impact shelf appeal
- > Complete with Dart Wallet

NEW



CORE PLUS
BLACK



08636 22g
08637 24g
08638 26g

- > Coated brass barrels
- > Gripper II shafts
- > Compact footprint
- > Engraved Unicorn Hallmark
- > High impact shelf appeal
- > Complete with Dart Wallet

NEW



Wallet included in all Core Plus packs



CORE PLUS
BRASS



08641 21g
08642 23g
08643 25g
08644 27g

- > Precision machined brass barrels
- > Gripper II shafts
- > Compact footprint
- > High impact shelf appeal
- > Complete with Dart Wallet

NEW

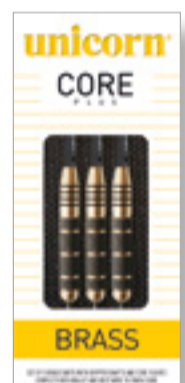

CORE TUNGSTEN



07773 21g
07774 23g
07775 25g
07776 27g

- > Quality materials
- > Quality engineering
- > Budget price
- > Gripper shafts
- > Very compact footprint for best sales density
- > Engraved Unicorn Hallmark



CORE BRASS



07768 21g
07769 23g
07770 25g

- > Pure quality 100% brass
- > Gripper shafts
- > Very compact footprint for best sales density



NEW RANGE

- › Concise range
- › Concentrated turnover
- › Fully sealed packs
- › Clam or blister packed
- › Only available to special order



71805
6 sets per master carton

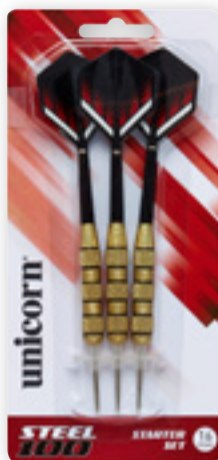

71807
6 sets per master carton

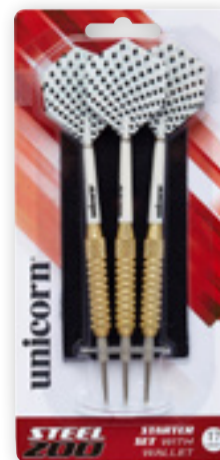

71810 17g **71811** 19g **71812** 21g
6 sets per master carton



71814 20g **71815** 22g **71816** 24g
3 sets per master carton



71819 21g **71820** 23g **71821** 25g
3 sets per master carton



71823 21g **71824** 23g **71825** 25g
3 sets per master carton



71827 21g **71828** 23g **71829** 25g
2 sets per master carton



71832 24g **71833** 26g
3 sets per master carton



71835 21g **71836** 23g **71837** 25g
2 sets per master carton



71842 22g **71843** 24g
2 sets per master carton



71944 17g
3 sets per master carton



77895
6 sets per master carton



77896
6 sets per master carton



77897
6 sets per master carton



WORLD CHAMPION NATURAL
90% TUNGSTEN

- › Barrel designs as used by RvB on TV
- › Natural Tungsten
- › World Champion Aluminium shafts
- › Guaranteed Weight Certified $\pm 0.1g$
- › Premium wallet
- › Engraved Unicorn Hallmark



PHASE 1



04037 17g
04038 19g

LP Finish

PURIST - BARRELS ONLY

PHASE 2



LP Finish

23197 19g

NEW

PHASE 3

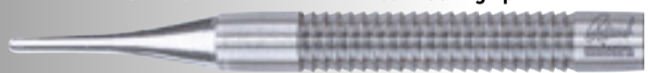

sawtooth grip

23200 18g

NEW

PHASE 2 DNA



23223 19g

NEW

PHASE 5



23221 19g

NEW

PURIST® PLAYER DEVELOPMENT LAB
90%/80% TUNGSTEN

- › Purist = Barrels only
- › Guaranteed Weight Certified $\pm 0.1g$
- › Purist wallet
- › Engraved Unicorn Hallmark

DNA FINISH BARRELS

- › DNA Titanium coating - each barrel unique

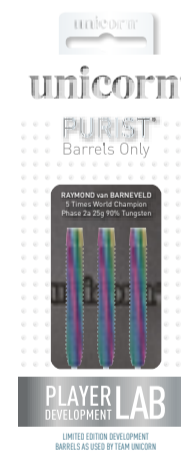



SILVER STAR™ 80% TUNGSTEN

- › Natural Tungsten
- › Gripper shafts
- › Compact case
- › Engraved Unicorn Hallmark



02827 17g
02828 19g

[See inside back cover for full cross-player ranges]



BLACK STAR 80% TUNGSTEN

- › Black Titanium PVD non-slip grip
- › Gripper shafts
- › Compact case
- › Engraved Unicorn Hallmark



04140 17g

[See inside back cover for full cross-player ranges]



BULLET® STAINLESS STEEL

- › Super Durable Stainless Steel
- › XL Aluminium shafts
- › Compact case
- › Engraved Unicorn Hallmark



02835 17g
02836 19g

[See inside back cover for full cross-player ranges]



BLACK BRASS

- › Matt Black brass barrels
- › XL shafts
- › Compact case
- › Engraved Unicorn Hallmark

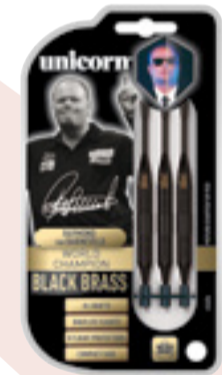

04080 17g
04081 19g

[See inside back cover for full cross-player ranges]



02880 16g
02881 18g

BARNEY BRASS

5 TIMES WORLD CHAMPION
RAYMOND van BARNEVELD ENDORSED

- › Colour coordinated
- › 100% brass barrels
- › Gripper shafts
- › Compact case



02887 18g



02890 18g



WORLD CHAMPION NATURAL

90% TUNGSTEN

PHASE 3

NEW



04187 18g

- › Barrel designs as used by Gary on TV
- › Natural Tungsten
- › World Champion Aluminium shafts
- › Guaranteed Weight Certified $\pm 0.1g$
- › Premium wallet
- › Engraved Unicorn Hallmark



DNA

NEW



23225 18g

PURIST® PLAYER DEVELOPMENT LAB

90% TUNGSTEN

- › Purist = Barrels only
- › Guaranteed Weight Certified $\pm 0.1g$
- › Purist wallet
- › Engraved Unicorn Hallmark



SILVER STAR™

80% TUNGSTEN



NEW



23208 17g
23209 19g

- › Natural Tungsten
- › Gripper shafts
- › Compact case
- › Engraved Unicorn Hallmark



[See inside back cover for full cross-player ranges]

BLACK STAR

80% TUNGSTEN



NEW



23216 17g

- › Black Titanium PVD non-slip grip
- › Gripper shafts
- › Compact case
- › Engraved Unicorn Hallmark



[See inside back cover for full cross-player ranges]

BULLET®

STAINLESS STEEL

NEW



23213 16g
23214 18g

- › Super Durable Stainless Steel
- › XL Aluminium shafts
- › Compact case
- › Engraved Unicorn Hallmark



[See inside back cover for full cross-player ranges]

BLACK BRASS

NEW

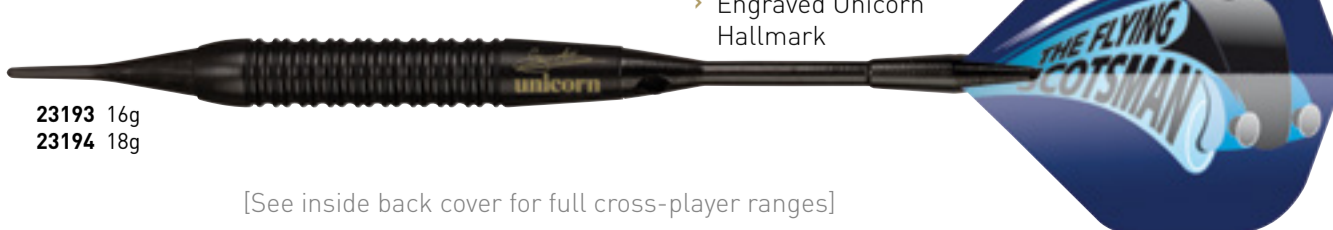

23193 16g
23194 18g

- › Matt Black brass barrels
- › XL shafts
- › Compact case
- › Engraved Unicorn Hallmark

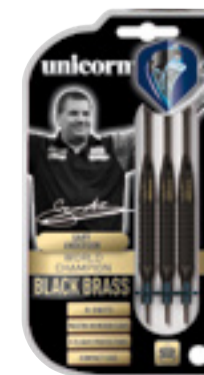

[See inside back cover for full cross-player ranges]

WORLD CHAMPION NATURAL 90% TUNGSTEN



04046 18g

04054 19g

- › Barrel designs as used by John or Bob on TV
- › Natural Tungsten
- › World Champion Aluminium shafts
- › Guaranteed Weight Certified $\pm 0.1g$
- › Premium wallet
- › Engraved Unicorn Hallmark



JOHN LOWE DNA

NEW



23227 18g

PURIST® PLAYER DEVELOPMENT LAB 90% TUNGSTEN

- › Purist = Barrels only
- › Guaranteed Weight Certified $\pm 0.1g$
- › Purist wallet
- › Engraved Unicorn Hallmark

BULLET® STAINLESS STEEL

JOHN LOWE



03222 20g

- › Super Durable Stainless Steel
- › XL Aluminium shafts
- › Compact case
- › Engraved Unicorn Hallmark



[See inside back cover for full cross-player ranges]

MAESTRO PREMIER

UNICORN PDC PREMIER LEAGUE PLAYERS

JAMES WADE PHASE 2



04106 20g (90% Tungsten)

KIM HUYBRECHTS



04119 19g (80% Tungsten)



MAESTRO® PREMIER NATURAL 80/90% TUNGSTEN

- › Barrel designs as used by Maestro Premiers on TV
- › Natural Tungsten
- › Aluminium shafts
- › Guaranteed Weight Certified $\pm 0.1g$
- › Premium wallet
- › Engraved Unicorn Hallmark

MAESTRO

MICHAEL SMITH

SILVER STAR™ 80% TUNGSTEN

NEW



23204 18g

23205 20g

- › Natural Tungsten
- › Gripper shafts
- › Compact case
- › Engraved Unicorn Hallmark

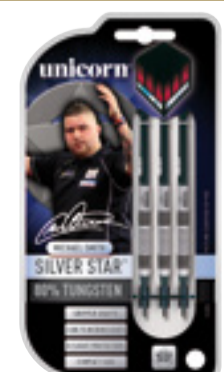

[See inside back cover for full cross-player ranges]



23145 18g

BLUE

23148 18g

ROSSO

23151 18g

BLACK

23154 18g

NATURAL

23157 18g

DNA

PHASE 5 MIRAGE 95% TUNGSTEN

- ▶ 1 set of guaranteed weight matched 95% tungsten barrels
- ▶ 1 set of Phase 5 Mirage DXM flights
- ▶ 1 set of Gripper Mirage shafts
- ▶ 1 Purist wallet
- ▶ Milled aluminium trident



MANTIS 90% TUNGSTEN

- ▶ Aggressive biting grip
- ▶ Checkout finger grip tips
- ▶ Gripper 3 shafts
- ▶ Feature Mantis 75 micron flights
- ▶ Engraved Unicorn Hallmark



04200 19g

NEW



04233 18g
04234 20g

NEW



04202 18g





NEW



04230 18g



04226 18g



04228 18g



KOI 90% TUNGSTEN

- › Precision engineered grip position
- › Aerodynamic barrel profile
- › Feature Koi 75 micron flights



- › Gripper 3 mirage shaft
- › Sigma soft tip
- › Milled aluminium trident



AUTOGRAPH® 80% TUNGSTEN



02870 19g

- › Configured by and for lady players
- › Subtle total coordination
- › Gripper shafts
- › White Compact case
- › Fully coordinated accessories available

Autograph
collection



B-FLY 90% TUNGSTEN



04206 19g
Emperor



04204 18g
Admiral

- › Checkout finger grip tips
- › Gripper 3 shafts
- › Feature B-FLY 75 micron flights
- › Engraved Unicorn Hallmark



NEW

NEON™ 70% TUNGSTEN



23219 18g

- › Shark tooth nose for controlled release
- › Complex machina rear grip
- › Aerodynamic barrel profile
- › DNA titanium coating - each barrel unique
- › Gripper 3 Mirage shafts
- › Neon Core .75 flights
- › Milled aluminium trident

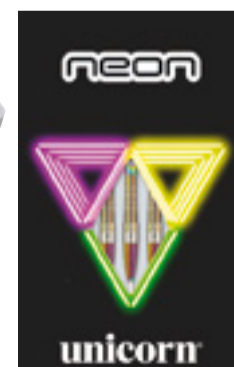
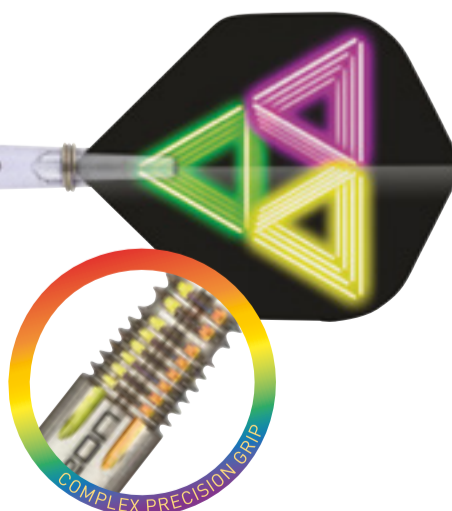



23164 18g



PHASE 1 PURIST® 90% TUNGSTEN

- › Purist = Barrels Only
- › Steel Tip version used on TV 1996 to 1999
- › Purist wallet
- › Engraved Unicorn Hallmark



23168 18g



PHASE 2 PURIST® 90% TUNGSTEN

- › Purist = Barrels Only
- › Steel Tip version used on TV 1999 to 2007
- › Purist wallet
- › Engraved Unicorn Hallmark



23172 18g



PHASE 3 PURIST® CURVE 90% TUNGSTEN

- › Purist = Barrels Only
- › Steel Tip version used on TV 2003
- › Purist wallet
- › Engraved Unicorn Hallmark



23175 18g



PHASE 5 PURIST® 95% TUNGSTEN

- › Purist = Barrels Only
- › Steel Tip version used on TV since 2008
- › Purist wallet
- › Engraved Unicorn Hallmark



23180 18g
23181 20g
23182 22g



PHASE 5 LP PURIST® 95% TUNGSTEN

- › Purist = Barrels Only
- › Steel Tip version used on TV 2013
- › Purist wallet
- › Engraved Unicorn Hallmark



23185 18g



PHASE 6 PURIST® 97% TUNGSTEN

- › Purist = Barrels Only
- › Steel Tip version used on TV 2011
- › Purist wallet
- › Engraved Unicorn Hallmark



Unicorn sponsored Phil Taylor for nearly 18 years from 1st April 1996 to 31st January 2014. Over that time, Phil used Unicorn designed and manufactured darts to win 12 World Championships, over 70 major televised tournaments and over £4 million in win prize money alone.

SUPER VALUE BONUS PACK
ALL CORE XL MODELS



- › Slimline case
- › Ultra slim
- › Durable



CORE XL T95
95% TUNGSTEN

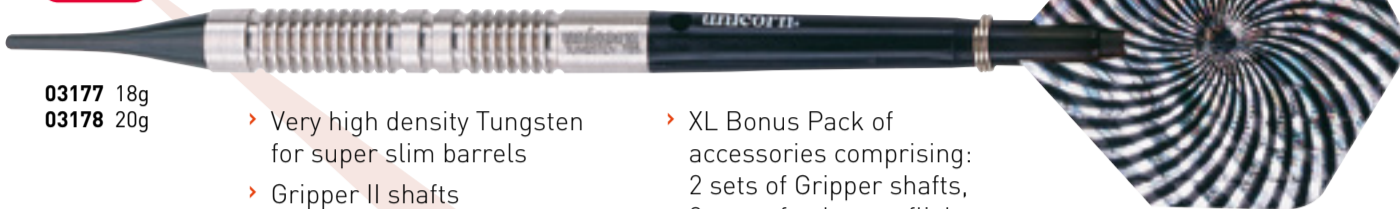

03177 18g
03178 20g

- › Very high density Tungsten for super slim barrels
- › Gripper II shafts
- › Slimline case
- › Engraved Unicorn Hallmark
- › XL Bonus Pack of accessories comprising: 2 sets of Gripper shafts, 2 sets of polyester flights, 8 flight protectors, 6 spare Gripper rings, 1 Checkout Chart



04088 17g



04089 18g



04090 19g

CORE XL T80
80% TUNGSTEN

- › Engraved Unicorn Hallmark
- › XL Bonus Pack of accessories comprising: 2 sets of Gripper shafts, 2 sets of polyester flights, 8 flight protectors, 6 spare Gripper rings, 1 Checkout Chart
- › Great value enhanced Tungsten range
- › Gripper II shafts
- › Slimline case



02904 18g



02918 19g



23229 18g



23231 17g

CORE XL STRIKER®
TUNGSTEN

- › Budget Tungsten dart sets
- › Gripper II shafts
- › Slimline case
- › XL Bonus Pack of accessories comprising: 2 sets of Gripper shafts, 2 sets of polyester flights, 8 flight protectors, 6 spare Gripper rings, 1 Checkout Chart



NEW

NEW

CORE PLUS
TUNGSTEN

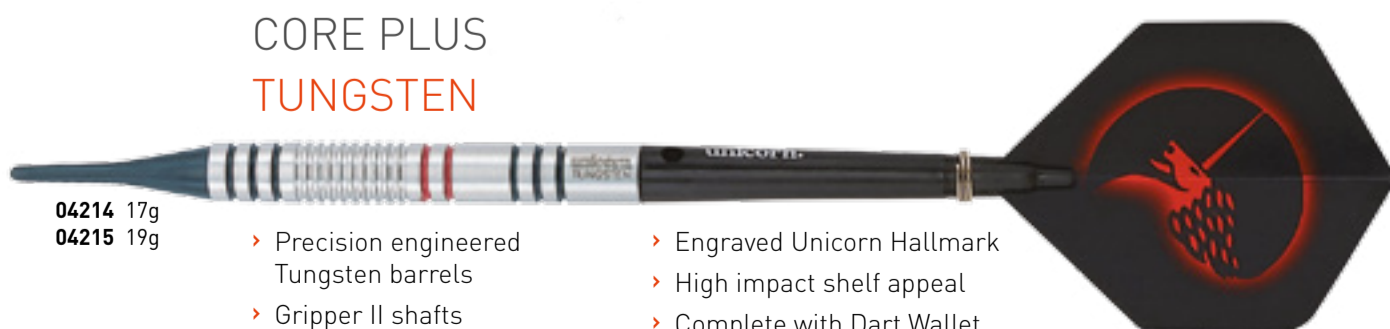

04214 17g
04215 19g

- › Precision engineered Tungsten barrels
- › Gripper II shafts
- › Compact footprint
- › Engraved Unicorn Hallmark
- › High impact shelf appeal
- › Complete with Dart Wallet

NEW



CORE PLUS
BLACK



04218 17g
04219 19g

- › Coated brass barrels
- › Gripper II shafts
- › Compact footprint
- › Engraved Unicorn Hallmark
- › High impact shelf appeal
- › Complete with Dart Wallet

Wallet included in all Core Plus packs

NEW



CORE PLUS
BRASS



04222 17g
04223 19g

- › Precision machined brass barrels
- › Gripper II shafts
- › Compact footprint
- › High impact shelf appeal
- › Complete with Dart Wallet

NEW

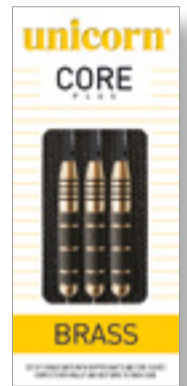

CORE TUNGSTEN

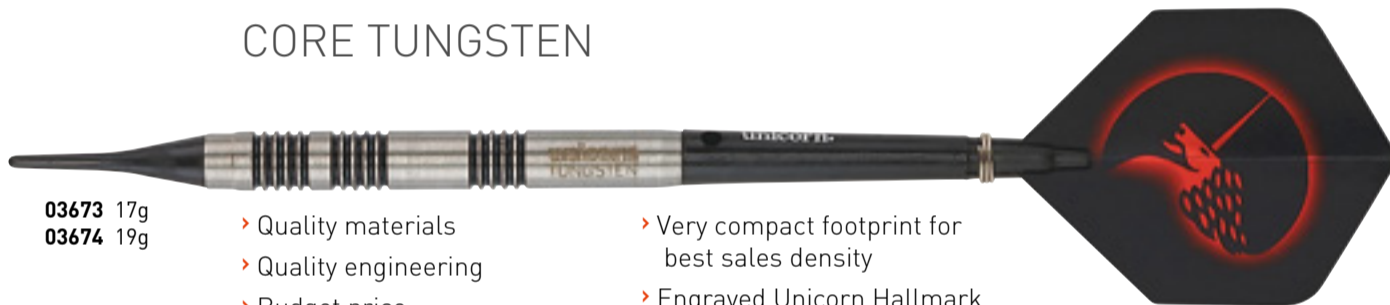

03673 17g
03674 19g

- › Quality materials
- › Quality engineering
- › Budget price
- › Gripper II shafts
- › Very compact footprint for best sales density
- › Engraved Unicorn Hallmark



CORE BRASS



03956 17g
03957 19g

- › Pure quality brass
- › Gripper II shafts
- › Very compact footprint for best sales density



CONTOUR TIP -
LONG BLK STD
S/T BRASS BARREL
1/4" x 1/4" 12g



71506/B
Blue

71506/BK
Black

71506/R
Red

71506/G
Green

71506/Y
Yellow

BAR DARTS
BRASS

- › Only supplied to special order Brass barrels
- › Available in a range of Flight colours
- › 100 darts per master carton

NEW RANGE

- › Concise range
- › Concentrated turnover
- › Fully sealed packs
- › Clam or blister packed
- › Only available to special order



71905
6 sets per master carton



71907 16g 71908 18g
6 sets per master carton



71910 17g 71911 19g
6 sets per master carton



71914 16g 71915 18g
3 sets per master carton



71919 15g 71920 17g
3 sets per master carton



71923 16g 71924 18g
3 sets per master carton



71927 16g 71928 18g
2 sets per master carton



71932 18g
3 sets per master carton



71935 18g
2 sets per master carton



71942 18g
2 sets per master carton



71944 17g
3 sets per master carton



77895
6 sets per master carton



77896
6 sets per master carton



77897
6 sets per master carton

DARTBOARDS

UNICORN DARTBOARD RANGE - THE INDUSTRY STANDARD

HD 20/20
WHITE DIGITAL
NUMBER RING
Registered Community Design
application no. 002044263

HD
SILVER
SPIDER

HD
STAPLE-FREE
SILVER BULLSEYE



ECLIPSE® HD TV EDITION BRISTLE

HIGH DEFINITION PROFESSIONAL DARTBOARD

- › Patent pending
- › Seamless playing surface for higher scores
- › HD 20/20 White digital number ring
- › HD Silver spider
- › HD Silver bullseye

79450 3 boards per master carton



THE INDUSTRY LEADING DARTBOARD
SEEN BY MILLIONS OF VIEWERS ON TV

HD 20/20
WHITE DIGITAL
NUMBER RING
Registered Community Design
application no. 002044263

HD
SILVER
SPIDER

HD
STAPLE-FREE
SILVER BULLSEYE



ECLIPSE® HD TRAINER BRISTLE

- › Dedicated practice board
- › Ultra slim doubles and trebles
- › Patent pending
- › Seamless playing surface for higher scores
- › HD 20/20 White digital number ring
- › HD Silver spider
- › HD Silver micro bullseye

79438 2 boards per master carton



THE PROFESSIONAL DARTS CORPORATION
CHOOSE AND RECOMMEND ONLY
UNICORN DARTBOARDS

Conventional wires
Eclipse wires
**THE ECLIPSE
ADVANTAGE!**



ECLIPSE® PRO BRISTLE

- › As used in all PDC tournaments
- › Championship quality bristle board
- › PDC endorsed
- › Designed to maximise averages
- › Unicorn high technology wiring design
- › Completely staple-free construction
- › Ultra-slim segmentation system - 30% thinner than conventional round wire boards
- › Increased target area - especially in Doubles and Trebles
- › Ultra high visibility number ring and spider
- › Staple-free Bullseye

79403 5 boards per master carton



UNICORN & PDC
#TheWinningDouble

DARTBOARDS

UNICORN DARTBOARD RANGE - THE INDUSTRY STANDARD



STRIKER® BRISTLE

- › Competition quality bristle board
- › PDC endorsed
- › High quality round wire construction
- › **SuperSlim™** wire fasteners to increase playing area
- › Staple-free Bullseye

79383 5 boards per master carton



DB180 BRISTLE

- › Great value, budget bristle
- › Competition quality bristle board
- › PDC endorsed
- › Full size playing area
- › High quality round wire construction
- › **SuperSlim™** wire fasteners to increase playing area
- › Staple-free bullseye
- › Checkout Chart on carton

79432 5 boards per master carton



XL BRISTLE

- › Full size playing surface
- › Top quality coiled paper dartboard
- › Double sided
- › Size 17" x 3/4"
- › Complete with 2 sets of darts

79085 6 boards per master carton



SOFT TIP ELECTRONIC DARTBOARDS



- › Suitable for up to 8 players
- › 25 games with 176 variations
- › LCD automatic scoring display

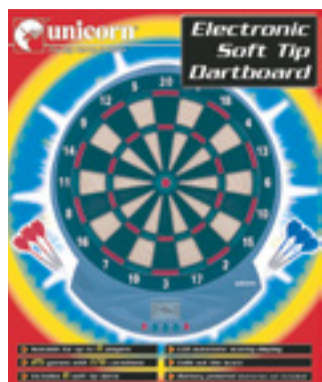

- › Includes 6 soft tip darts
- › Requires 3 AA batteries (not included)

79511 6 boards per master carton



- › Suitable for up to 8 players
- › 25 games with 176 variations
- › LCD automatic scoring display



- › Play against the computer feature
- › Includes 6 soft tip darts
- › Requires 3 AA batteries (not included)

79527 6 boards per master carton

HOME DART CENTRES PERFORMANCE, INNOVATION AND VALUE

STRIKER® BOARD & SURROUND HOME DARTS CENTRE

- › Striker EVA dartboard surround
- › Striker bristle dartboard
- › Complete with 2 sets of darts

46122 2 per master carton



STRIKER® HOME DARTS CENTRE

- › Wooden cabinet with shaped doors
- › Wipe-clean whiteboards on door inners for scoring
- › Striker bristle dartboard with SuperSlim™ wire fasteners and staple-free Bullseye
- › Complete with 2 sets of darts
- › PLUS marker pen and wiper
- › PLUS Checkout Chart

46136 2 cabinets per master carton



DB180 HOME DARTS CENTRE

- › Fold out construction for wall protection
- › Incorporates 2 wipe clean scoreboards
- › Unicorn DB180 Bristle Dartboard
- › 2 sets of darts
- › Marker pen and wiper
- › Dart and marker pen holder

46165 3 per master carton



SURROUNDS, CLAMPS & CABINETS

PERFORMANCE, INNOVATION AND VALUE



TEKNIK™ CABINET

- › Tough, stylish aluminium frame
 - › Unique adjustable fixing system
 - › Fits 18" bristle or paper boards from 3/4" to 1 1/2" thick
 - › Includes Checkout Chart and oche
- 46020** 3 cabinets per master carton
Dartboard & Darts not included



STRIKER® EVA DARTBOARD SURROUND

- › Lightweight injection moulded EVA protection ring
- › Holds dart points securely
- › Virtually eliminates the risk of 'bounce-outs' from near misses
- › Protects surrounding area from accidental surface marks and damage
- › Clamps around a standard bristle dartboard with no fixings required
- › Dartboard not included



79363 Blue **79360** Red **79361** Black
Master pack of 5 one colour



PROFESSIONAL DARTBOARD SURROUNDS

- › Ultra heavy duty
- › Injection moulded plastic protection ring
- › High density material holds dart points securely
- › Virtually eliminates the risk of 'bounce-outs' from near misses
- › Protects surrounding area from accidental surface marks and damage
- › Clamps around a standard bristle dartboard with no fixings required
- › Dartboard not included



79374 Red **79375** Blue **79376** White
79378 Green **79373** Black
Master pack of 5 one colour



DARTBOARD WALL CLAMP

- › Robust spring-loaded clamp securely holds a bristle dartboard
 - › Wall mounted
 - › Fixing kit and full instructions supplied
 - › Allows board to be rotated as required
 - › Ideal for use in conjunction with the Unicorn Dartboard Surround
- 79379** Dartboard not included

TEKNIK 360 MAGNETIC DARTBOARD HOLDER

- › PATENT APPLIED FOR NO. GB0911142.8
 - › Clever two piece all metal design locates board securely and safely on wall
 - › Innovative construction gives precise rotation and vertical alignment
 - › Easy up! Supplied with fixing kit and instructions
- 79427** 6 holders per master carton

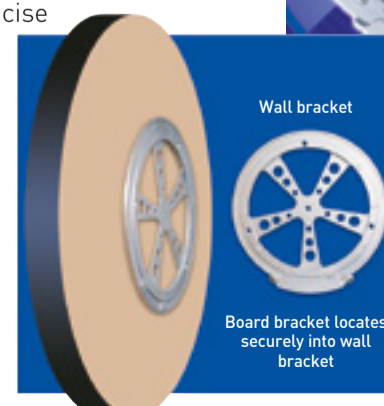

ACCESSORIES

PERFORMANCE, INNOVATION AND VALUE



PRO DARTMATE

- > The Ultimate Free Standing Board and Oche Assembly
- > Sturdy construction for maximum stability
- > 4 adjustable feet
- > Integral backboard with 2 scoreboards
- > Marker pen and wiper
- > Eclipse Pro dartboard
- > OcheMate
- > Strong zipped carry bag
- > 106cm x 74cm x 24cm - 24 kg

85178 Master pack of 1
(Raised Oche not included)

RAISED OCHE

- > Lightweight
- > 4 piece clip together construction
- > Raised toe line
- > Fully adjustable for length
- > Can be set to compensate for most thicknesses of skirting board
- > Complete with zipped carry bag
- > 63cm x 60cm x 4cm - 7 kg

86656 Master pack of 3



SCOREBOARD

- > Extra large wipe clean scoreboard
 - > Size 400 x 570mm (15³/₄ x 22¹/₂" approx)
 - > Complete with Marker Pen
 - > Magnetic wiper park
- 46003 Master pack of 1**

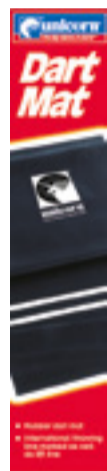

PROFESSIONAL DART MAT

- > Heavy duty rubber dart mat
- > International throwing line marked as well as 8ft line

86055 Master pack of 1



STRIKER® DART MAT

- > Lightweight EVA dart mat
- > International throwing line marked as well as 8ft line

86659 Master pack of 1



DARTMATE

- > The improved version of the original Free Standing Board & Cabinet
 - > Used by most of the world's best known players
 - > Holds the board at the regulation height
 - > Fully portable – folds down into 2 easily carried packs
 - > Can be used anywhere
 - > Ideal for exhibitions or practice
 - > Complete with full instructions
 - > Includes Eclipse Pro tournament bristle dartboard
 - > Includes OcheMate
 - > 136 x 16 x 17 cm - stand
 - > 12 x 51 x 51 cm - cabinet
 - > Total weight with board and printed cartons 12 kg
- 85139 Master pack of 1 (comprises 2 cartons)**

OCHE

- > Self adhesive Oche
- 86053 Master pack of 1**



OCHEMATE

- > At last, a simple and foolproof way to set up a dartboard ready for tournament play
- > Incorporates a unique measure for the diagonal from the Oche to the centre Bullseye
- > Also measures both vertical and horizontal dimensions
- > Complete with easy to follow instructions

76115 Master pack of 6



UNICORN ON TOUR

The ultra portable system that enables you to use your dartboard in virtually any location that has a door!

The system comprises:-

- > Unicorn Eclipse Pro Board
- > Unicorn OcheMate for precise set-up
- > Unicorn short Oche mat
- > Dartboard mounting with adjustable door fixing and external safety warning notice
- > Complete with specially designed convenient carry bag
- > 48cm x 48cm x 10 cm - 7 kg

46001 Master pack of 1



SELECTING UNICORN FLIGHTS

UNICORN FLIGHT DESIGNS ARE UNIQUE AND ARE ONLY AVAILABLE FROM UNICORN

THE UNILAB FLIGHT SELECTOR TABLE

The UniBoffin explains:

The right flights for you must match your particular darts, producing enough aerodynamic lift to stabilise them in-flight but not so much as to throw them off-course. UniLab and Unicorn Sigma darts use sophisticated mathematics to achieve this matching, but you can try yourself using the following table, some experimentation, and maybe a UniLab Flight Selector Kit!

The table below lists the surface area for current Unicorn flight shapes, a Lift Factor relative to the highest lift Big Wing flights, and a related Stability Factor. Flight weight also affects stability and, although the Stability Factor shown is for a

standardised material, the table's last row shows the weight of a representative Plus flight in different materials.

Heavier materials provide slightly less stability but improved durability, Maestro additionally offers more rigidity and therefore consistency of flight, and Q aims to provide this in a lighter flight.

There are no hard-and-fast rules on flights matching, but as a hint to using the table, if your darts are landing in the board at varying angles, try a higher stability flight, if they're landing true, a smaller, lower lift flight may improve accuracy, land flatter, and reduce bed-blocking.

FLIGHT SHAPE	AREA cm ²	LIFT FACTOR	STABILITY FACTOR (standardised material)	CHARACTERISTICS & COMMENTS
Big Wing XL	47.658	1.05	1.02	The most lift from the biggest flight!
Big Wing	44.741	1.00	1.00	Increasingly popular - the table baseline
Plus	39.614	0.87	0.93	The all-purpose compromise
Fin	38.765	0.78	0.90	An Xtra take off from a retro rocket
Xtra	36.323	0.74	0.85	Works well with a straighter throw
Shield	34.979	0.77	0.88	Shields against instability
Slim	32.846	0.57	0.59	Works well with a flatter, direct throw
DXM	26.585	0.51	0.57	A trim of the slim
Sigma Flights				Mathematically matched to Sigma darts
One	37.519	0.93	1.05	Stability-optimised stall-resistant design
Pro	29.249	0.66	0.74	For accuracy with side-loading shafts
Super Pro	25.265	0.55	0.59	Shorter for accuracy with end-loaders only

WEIGHT OF A PLUS FLIGHT IN DIFFERENT MATERIALS (gms)					SIGMA RANGE			
SuperTrue .125	Core .75	Q .75	Q .100	Maestro .100	Super Maestro .125	One.100	Pro.100	Super Pro.100
0.63g	0.53g	0.53g	0.65g	0.65g	0.75g	0.60g	0.48g	0.42g

SEE TABLE BELOW FOR FLIGHT SHAPE SYMBOLS

UNILAB FLIGHT SELECTOR KIT

- ▶ A direct spin-off from UniLab, our unique online Darts Tuning application, the UniLab Flight Selector Kit enables you to experiment with different flight configurations.
- ▶ Different flight shapes and sizes will alter a dart's trajectory, working aerodynamically in conjunction with your existing barrels and shafts.
- ▶ Try these 5 different shapes to tweak your darts set up to improve your accuracy and consistency.

Try UniLab for yourself and read more about the science of darts at www.unicorn-darts.com



77790 Master pack of 12



Refer to symbols, Select P BX B S X D F or SH, Quote item number. Flights are supplied blister carded, 12 sets per pack.



PLUS 39.614cm²
The original Unicorn Flight shape that's now copied as a standard shape worldwide as it's an ideal general purpose flight that suits all styles of play and Dart/Shaft combinations.



BIG WING XL 47.658cm²
The biggest flight ever, giving maximum lift.



BIG WING 44.741cm²
These Extra Large Flights (+13% bigger than Plus shape) give Extra Lift and are becoming increasingly popular with top players.



XTRA 36.323cm²
For accurate players, the unique Xtra shape allows the closest groupings.



SLIM 32.846cm²
Lightweight Flights for lighter weight Darts, especially soft tip where they're used by most of Unicorn's top players.



DXM 26.585cm²
For consistently accurate players these ultra compact flights improve visibility and close grouping.



FIN 38.765cm²
For improving players, step up to Fin to improve grouping.



SHIELD 34.979cm²
Shields against instability and allows for close grouping.

SELECTING UNICORN FLIGHTS

UNICORN FLIGHT DESIGNS ARE UNIQUE AND ARE ONLY AVAILABLE FROM UNICORN

Sigma™ .100 CUTTING EDGE TECHNOLOGY. PERFORMANCE ENHANCING.

100 MICRON NOMINAL MATERIAL THICKNESS.



SIGMA SUPER PRO
68447 WHITE



SIGMA SUPER PRO
68448 SILVER



SIGMA SUPER PRO
68536 BLACK



SIGMA ONE 68434



SIGMA ONE 68537



SIGMA ONE 68263



SIGMA PRO 68262



SIGMA PRO 68394



SIGMA PRO 68433



SIGMA PRO 68538



.100 & .75 SUPER-WAVE RIBBED FLIGHTS. INCREASED RIGIDITY, BETTER FLIGHT STABILITY.

100 & 75 MICRON NOMINAL MATERIAL THICKNESS.



P 68509 **Q.100**

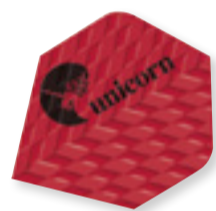

P 68511 **Q.100**



P 68510 **Q.100**



RAYMOND VAN BARNEVELD
S 68499 **P** 68496 **Q.100**



RAYMOND VAN BARNEVELD
S 68501 **P** 68497 **Q.100**



P 68505 **F** 68532 **Q.100**



P 68504 **Q.100**



P 68577 **F** 68533 **Q.100**



SH 68604 **Q.75**



SH 68605 **Q.75**



P 77615 **Q.75**



BX 68606 **Q.75**



BX 68607 **Q.75**



P 68540 **B** 68541
F 68542 **Q.75**



P 68543 **B** 68544
F 68545 **Q.75**



P 68546 **B** 68547
F 68548 **Q.75**

Super Maestro® .125 SUPER RIGID. ULTRA DURABLE.

125 MICRON NOMINAL MATERIAL THICKNESS.



P 68517 **D** 68549
B 68550 **F** 68551



P 68515 **D** 68552
B 68553 **F** 68554



P 68516 **D** 68555
B 68556 **F** 68557

SELECTING UNICORN FLIGHTS

UNICORN FLIGHT DESIGNS ARE UNIQUE AND ARE ONLY AVAILABLE FROM UNICORN

Maestro® .100 THE CHOICE OF MANY TEAM UNICORN PROFESSIONALS.
33% THICKER THAN CORE.75 FOR INCREASED RIGIDITY.

100 MICRON NOMINAL MATERIAL THICKNESS.



D 68596 P 68646



D 68597



D 68598 P 68647



D 68599 P 68648



D 68600



D 68617 S 68618
P 68645

NEW



SH 68608



SH 68609



BX 68610



BX 68611



P 68649



P 68650

NEW

NEW



P 68528 F 68529

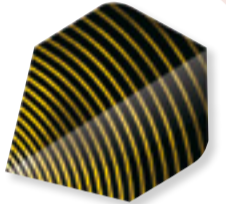

P 68526 F 68527



P 68134



P 68240



P 68651

NEW



P 77683 S 77684
D 68481



P 77686



P 77687 S 68193
X 68194 D 68483



P 77688 S 77689
X 68195 D 68484
B 68112 F 68539



P 77690 S 77695
X 68196 D 68482
B 68113 F 68560



P 77681



P 77780



P 77778



P 77779



P 68109



P 68103 B 68102



P 68172



P 68491



P 68144



B 68245
1 flight 2 different faces



P 68142
1 flight 2 different faces



SuperTrue .125 TRUE 90° ANGLE. EASY INSERTION.
LIGHT BUT DURABLE POLYMER. INTEGRATED SPRING SLOT.

125 MICRON NOMINAL MATERIAL THICKNESS.

SuperTrue .125 flights are supplied clam packed, 10 sets per pack.



P 30241
SuperTrue .125



P 30242
SuperTrue .125



P 30243
SuperTrue .125



P 30244
SuperTrue .125



P 30245
SuperTrue .125

NEW

NEW

NEW

NEW

NEW

SELECTING UNICORN FLIGHTS

UNICORN FLIGHT DESIGNS ARE UNIQUE AND ARE ONLY AVAILABLE FROM UNICORN

Authentic .125, .100 & .75

100 & 75 MICRON NOMINAL MATERIAL THICKNESS.

					
BLUE BARNEY 5 TIMES P 68595 Authentic .125	RED BARNEY 5 TIMES B 68644 Authentic .125	KYLE ANDERSON B 68582 Authentic .125	ORANGE BARNEY 5 TIMES SH 68591 Authentic .100	GARY ANDERSON B 68464 S 68465 Authentic .100	GARY ANDERSON COMPETITION B 68490 Authentic .100
					
JAMIE CAVEN X 68420 Authentic .100	MICHAEL SMITH P 68590 Authentic .100	JAMES WADE P 68436 Authentic .75	FLYING SCOT GARY ANDERSON B 68466 Authentic .100	ANDY HAMILTON P 68439 Authentic .75	RAYMOND VAN BARNEVELD P 68403 Authentic .75
					
BLACK BARNEY 5 TIMES B 68485 P 68486 Authentic .100	WEZ NEWTON P 68454 Authentic .75	KIM HUYBRECHTS B 68592 Authentic .75	TERRY JENKINS P 68435 Authentic .75	JOHN LOWE X 77665 Authentic .75	JAMES WADE P 77116 S 77114 Authentic .75

Core .75 STRIKING HOLOGRAM, METALLIC & PHOTO-REALISTIC POLYESTER FLIGHTS.

75 MICRON NOMINAL MATERIAL THICKNESS.

						
B 68640	B 68643	P 68627 B 68628 X 68629	P 68630 B 68631 X 68632	P 68633 B 68634 X 68635	P 68636 B 68637 X 68638	P 68641 Transparent material
						
P 68563	P 68564	P 68565	P 68566	P 68558 F 68559	P 68428	
						
P 68341	P 68337	P 68339 X 68340	P 77394	P 77443	P 68432	

SELECTING UNICORN FLIGHTS

UNICORN FLIGHT DESIGNS ARE UNIQUE AND ARE ONLY AVAILABLE FROM UNICORN

Core .75 STRIKING HOLOGRAM, METALLIC & PHOTO-REALISTIC POLYESTER FLIGHTS.

75 MICRON NOMINAL MATERIAL THICKNESS.



P 68652 P 68653 P 68654 P 68655 P 68656 P 68335 P 68431

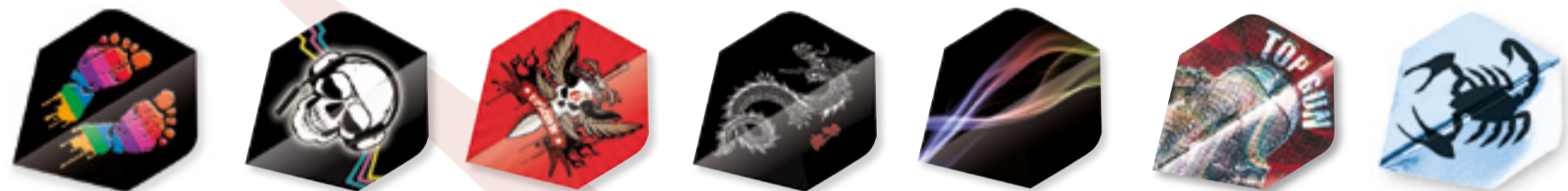

P 68332 P 68322 P 68319 P 68375 X 68376 S 68377 F 68575 P 68368 P 77296 P 77407



P 77763 X 68205 B 68206 F 68567 P 77760 B 68208 F 68568 P 77750 P 77402 P 68430 P 77401 1 flight 2 different faces

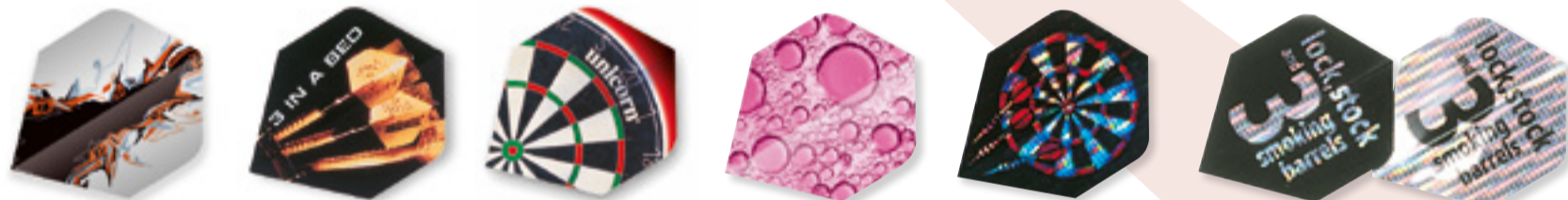

P 68427 P 77717 P 77766 B 68214 P 68381 P 77559 P 77380 Two-sided flight



P 68224 P 77404 1 flight 4 different faces X 77454 1 flight 4 different faces



P 68324 X 68325 F 68561 P 68388 S 68390 F 68562 P 68507 P 68508 P 77748 P 77290 Supplied assorted



P 68503 P 68506 P 77300 1 flight 2 different faces P 68429 1 flight 2 different faces P 68480 1 flight 2 different faces

SHAFTS

REPEAT CONSUMABLES



CARBON FIBRE SHAFTS

Aerospace developed Carbon Fibre for outstanding rigidity and strength for any given diameter.

High performance, outstanding strength : weight ratio

unicorn

OMEGA[®] SLIM

- > Super-tough, Super-rigid carbon fibre shaft
- > Co-polymer adaptor
- > **Small Thread**
- > **Length** 44.0mm
- > **Weight** 0.67g



78717

XTL[™] CARBON

- > Super-tough, Super-light carbon fibre shaft
- > Made entirely from Carbon Fibre
- > **Small Thread**
- > **Length** 45.6mm
- > **Weight** 0.61g



78606

OMEGA[®] CARBON

- > Super-tough, Super-rigid carbon fibre shaft
- > Made entirely from Carbon Fibre
- > **Small Thread**
- > **Length** **S** 33.0mm
M 44.3mm
- > **Weight** **S** 0.87g
M 1.14g



78609 78607

BANTAM[™] CARBON

- > Co-polymer flight holder
- > Carbon fibre shaft
- > Aluminium base
- > Shaft can be cut to length
- > **Small Thread**
- > **Length** 53.0mm
- > **Weight** 0.90g

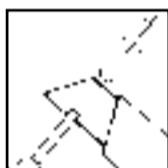

Length adjustable: Remove top, cut off to desired length, replace top.



78605

Spare tops for use with Bantam[™] Carbon and JetStem[®] Carbon shafts



78227

JETSTEM[®] CARBON

- > Carbon fibre shaft
- > Aluminium flight holder and base
- > **Small Thread**
- > **Length** 50.8mm
- > **Weight** 1.16g



78603

SIGMA[™] SUPER PRO CARBON

- > Super-tough, Super-light carbon fibre shaft
- > Made entirely from Carbon Fibre
- > Optimised for use with Sigma Darts
- > **Small Thread**
- > **Length** 45.3mm
- > **Weight** 0.65g



78690

SIGMA[™] ZERO D CARBON NOSE CONE

SIGMA[™] 25mm Plain
SIGMA[™] 25mm Finger grip

All fitted with steel points.
Sets of 3 packed in dozens of one length

TO SEE OUR FULL RANGE OF NOSE CONES AND SPARE POINTS GO TO PAGE 50



78035 78036

Sigma[™] Shafts

SIGMA[™] PRO Ti

- > Simple and secure side loading design
- > 100% Titanium base
- > Durable hi-flex flight holder
- > Built in flight protector
- > Optimised for use with Sigma Pro Darts
- > Replaceable flight holders
- > **Small Thread**
- > **Length** 74.4mm
- > **Weight** 1.97g



78653

78684

SIGMA[™] PRO MAGNESIUM

- > Ultra light Magnesium alloy base
- > Simple and secure side loading design
- > Durable hi-flex flight holder
- > Built in flight protector
- > Replaceable flight holders
- > **Small Thread**
- > **Length** 74.4mm
- > **Weight** 1.04g



78604

SIGMA[™] SUPER PRO MAGNESIUM

- > Ultra light
- > Magnesium alloy
- > **Small Thread**
- > **Length** 45.0mm
- > **Weight** 0.90g



78610

SIGMA[™] CR

- > Optimised carbon polymer mix
- > Light, strong, flexible
- > Sigma certified
- > Small Thread
- > **Length** **S** 34.4mm
M 44.2mm
- > **Weight** **S** 0.78g
M 1.03g



78725 78726

SIGMA[™] ONE

- > Specifically designed rigid shafts
- > Optimised for use with Sigma One Darts
- > **Small Thread**
- > **Length** 46.3mm
- > **Weight** 0.67g



78654

PHASE 5/SIGMA[™] SPARE TOPS

- > Screw-in spare flight holders



78597 78595 78598 78596 78599 78600

Whilst carbon fibre exhibits tremendous strength for any given weight, flights and shafts are the consumable items in the sport of darts and will need periodic replacement.
Shaft lengths stated exclude the thread.

SHAFTS

REPEAT CONSUMABLES

PHASE 5

- › Simple and secure side loading design
- › 100% Titanium base
- › Durable hi-flex flight holder
- › Built in flight protector
- › Added grip to base of shaft
- › Replaceable flight holders
- › **Small Thread**
- › **Length** 74.4mm
- › **Weight** 1.97g



78664 78665 78669 78688 78689

XL SHAFTS



- › 100% Titanium
- › Ultra strong
- › Virtually unbreakable
- › **Small Thread**
- › **Length** S 35.3mm M 45.2mm
- › **Weight** S 1.63g M 2.02g



78569 78570 78670 78671 78722
DNA FINISH

XL ANODISED ALUMINIUM

- › Anodised aluminium alloy shaft
- › **Small Thread**
- › **Length** S 35.1mm M 45.6mm
- › **Weight** S 1.15g M 1.32g



78294 78296

VALUE PACK
5 SETS

XL ALUMINIUM

- › Precision natural aluminium alloy shaft
- › **Small Thread**
- › **Length** S 35.1mm M 45.6mm
- › **Weight** S 1.15g M 1.32g



78280 78281



Medium 78289



- › Ultra longlife, retains flexibility and recovers shape even after many hours of play
- › **Small Thread**
- › **Length** S 33.7mm M 46.5mm
- › **Weight** S 0.55g M 0.67g



78150 78152

Shaft lengths stated exclude the thread.

SlikStik Shafts

SLIKSTIK®

Probably the best dart shaft in the world

- › Ultra longlife 21st century material
- › Retains shape and flexibility
- › Perfect in-flight balance
- › Easiest possible side-load action
- › Flight held securely
- › Built-in flight protector
- › Choice of lengths

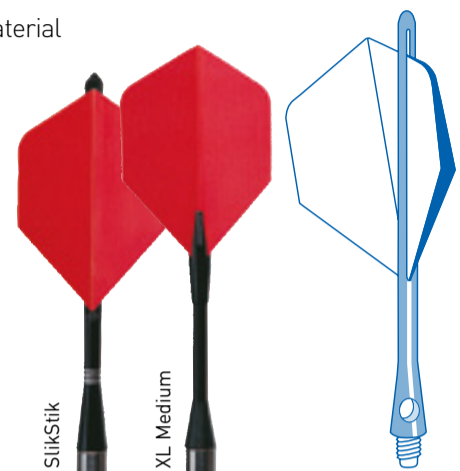

SlikStik

XL Medium

SLIKSTIK®



- › Now available in two lengths
- › High flex strength
- › **Small Thread**
- › **Length** S 56.6mm M 72.3mm
- › **Weight** S 0.46g M 0.70g



74121 74123 74129 74140 74194 74187

SlikStik® Aluminium

- › Ultra light anodised aluminium adaptor
- › Choice of colours
- › **Small Thread**
- › **Length** S 65.5mm M 74.5mm
- › **Weight** S 1.00g M 1.29g



74431 74432 74435 74436 74437 74441 74442 74445 74446 74447

SHAFTS

REPEAT CONSUMABLES

Aluminium Shafts

MAESTRO®

- > Diamond cut anodised aluminium alloy shaft
- > Length 50mm - 10% longer than standard 46mm shafts
- > **Small Thread**
- > **Length** 50.9mm
- > **Weight** 2.07g

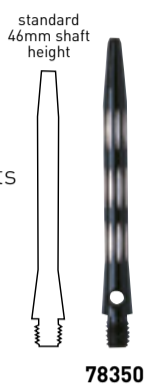

GT ALUMINIUM

- > Anodised aluminium shafts
- > Knurled design for extra grip
- > **Small Thread**
- > **Length**
S 35.2mm
M 45.7mm
- > **Weight**
S 1.28g
M 1.50g



ALI 360™

- > Aluminium dart shafts with fully rotating tops
- > Longer slots give greater flight engagement
- > **Small Thread**
- > **Length** U 34.6mm S 39.9mm M 45.1mm
- > **Weight** U 1.29g S 1.54g M 1.77g

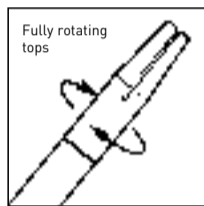

WORLD CHAMPION™

- > Spiral diamond cut anodised aluminium alloy shaft
- > **Small Thread**
- > **Length**
S 34.9mm M 45.2mm
- > **Weight**
S 1.14g M 1.54g



FLAIR®

- > Anodised aluminium shaft
- > Self-lock adaptor
- > Acetal co-polymer adaptor
- > Stays locked
- > No fiddly washers
- > **Small Thread**
- > **Length** M 45.3mm
- > **Weight** M 1.42g



MACHINA™

- > Deep machined aluminium
- > Great back end grip for control
- > **Small Thread**
- > **Length** 44.3mm
- > **Weight** 1.85g



TWIST®

- > Precision machined
- > Great back end grip for control
- > **Small Thread**
- > **Length** 44.8mm
- > **Weight** 1.31g



CHECKOUT®

- > Flexible moulded shafts
- > Anodised aluminium tops
- > **Small Thread**
- > **Length**
S 31.9mm
M 50.5mm
- > **Weight**
S 0.81g
M 1.12g



Shaft lengths stated exclude the thread.

Moulded Shafts

GRIPPER® 3

MIRAGE

- > Moulded shafts
- > Easy-flight load
- > Super lock flight hold
- > Spring compression for security
- > **Small Thread**
- > **Length**
S 34.4mm
M 44.2mm
- > **Weight**
S 0.78g
M 1.03g



GRIPPER® 3 TWO-TONE

- > Moulded shafts
- > Easy-flight load
- > Super lock flight hold
- > Spring compression for security
- > **Small Thread**
- > **Length**
S 34.4mm
M 44.2mm
- > **Weight**
S 0.78g
M 1.03g



Fully rotating tops

NEW

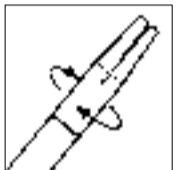

GRIPPER® 360 TWO-TONE

- > Gripper Two-Tone shaft
- > Full 360° rotating shafts
- > Alloy tipped flight holders
- > **Small Thread**
- > **Length** M 44.9mm
- > **Weight** M 1.13g



GRIPPER® SOFTFLEX

- > Soft feel outer
- > Flexible core
- > Superb flight grip

NEW

- > **Small Thread**
- > **Length** M 44.2mm
- > **Weight** M 1.03g



SHAFTS

REPEAT CONSUMABLES

GRIPPER® GT

- › Moulded shafts with extra finger grip
- › Spring compression for security
- › **Small Thread**
- › **Length S** 33.4mm **M** 44.2mm
- › **Weight S** 0.79g **M** 1.08g



78674 78678 78680 78676 78682 78675 78679 78681 78677 78683

GRIPPER® 360

- › Full 360° rotating shafts
- › Alloy tipped flight holders
- › **Small Thread**
- › **Length U** 35.0mm **S** 40.1mm **M** 44.9mm
- › **Weight U** 0.95g **S** 1.04g **M** 1.13g

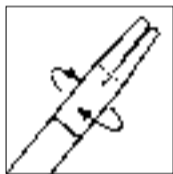

Fully rotating tops



78660 78661 78662

GRIPPER® 3

- › Moulded shafts
- › New profile
- › Easi-flight load
- › Super lock flight hold
- › Spring compression for security
- › **Small Thread**
- › **Length S** 34.4mm **M** 44.2mm
- › **Weight S** 0.78g **M** 1.03g



Short Medium



Length
Short **78702** **78706** **78710**
Medium **78703** **78707** **78711**



VALUE PACKS
5 SETS

Black **78616** **78619**
White **78617** **78620**



CANISTER
MEGA PACK:
CONTAINS 45
SHAFTS

Black Medium
78501

6 canisters per Master carton

GRIPPER® 2

- › Moulded shafts
- › Spring compression for security
- › **Small Thread**
- › **Length** **U** 27.4mm **U** 0.67g
- › **S** 32.7mm **S** 0.75g
- › **M** 44.0mm **M** 1.03g



Ultra Short Short Medium



Length	78146	78546	78549	78555	78558	78531
Ultra Short	78146	78546	78549	78555	78558	78531
Short	78145	78547	78550	78556	78559	78532
Medium	78148	78548	78551	78557	78560	78533

VALUE PACKS
5 SETS

Short **78613** Medium **78614**



CATALYST®

- › Moulded shafts
- › Spring compression grips the flight for extra security
- › **Small Thread**
- › **Length S** 36.0mm **M** 44.4mm
- › **Weight S** 0.85g **M** 1.04g

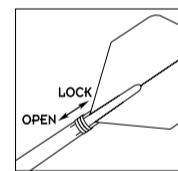

78622 78624
Short Medium

Specialist

JETSTEM®

- › Slim, light, durable hardened, tempered, plated steel shaft with acetal co-polymer adaptor and replaceable Jet Tops
- › **Small Thread**
- › **Length S** 45.4mm **M** 49.8mm
- › **Weight S** 1.21g **M** 1.37g

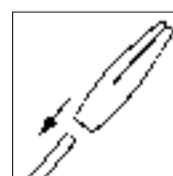

78218 78224

JET TOPS

- › For JetStem®, JetStem® Carbon and Bantam™ Carbon shafts



78227

THREAD WASHERS WITH APPLICATOR

- › Pack of 25

78237



Shaft lengths stated exclude the thread.

SPARE STEEL TIPS

IMPORTANT REPEAT SALES

CONVERTA 360 SPARE POINTS

- › Converts soft tip darts to steel tip in seconds
- › Lengths short 7/8" & long 1 1/8"
- › Points rotate allowing following darts to deflect

- 78589** – Short Red
- 78590** – Short Black
- 78593** – Long Red
- 78594** – Long Black

Sets of 3 packed in dozens of one length, one colour



UNITOOL 1

- › Quick and easy repointing tool.
- › For use with all Unicorn darts and points.
- › Will not put a strain on the dart
- › Assured alignment of point and barrel
- › Complete with 6 standard, 6 short, 6 finger and 6 board points
- › Available in Black and Pink Power!

- 46094 Black** 1 per pack
- 46141 Hi Viz** 1 per pack



SIGMA™ ZeroD TITANIUM NOSE CONES

- 78030** – SIGMA™ ZeroD 25mm Plain
- 78031** – SIGMA™ ZeroD 25mm Finger grip
- 78040** – SIGMA™ ZeroD 28mm Plain
- 78041** – SIGMA™ ZeroD 28mm Finger grip

All fitted with steel points.
Sets of 3 packed in dozens of one length



SIGMA™ ZeroD CR NOSE CONES

- 78045** – SIGMA™ ZeroD CR 25mm Plain
- 78046** – SIGMA™ ZeroD CR 25mm Finger grip
- 78055** – SIGMA™ ZeroD CR 28mm Plain
- 78056** – SIGMA™ ZeroD CR 28mm Finger grip

All fitted with steel points.
Sets of 3 packed in dozens of one length



REPLACEMENT POINTS WITH ENGINEERED GRIPS

- › Cards of 3 of a pattern:



Knurled grip points



Board grip points

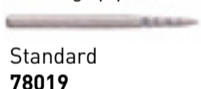

Needle Standard 6 Groove points

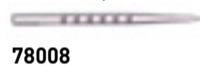

Finger grip points



Standard points

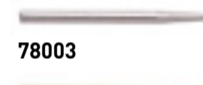

78037

78038

Needle Extra Long 6 Groove points

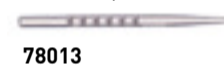

Needle Extra Long points



SPARE SOFT TIPS

TO SPECIAL ORDER ONLY, SPARE TIPS ARE ALSO AVAILABLE IN BAGS OF 1,000 AS FOLLOWS:

CHECKOUT® SOFT TIPS

- › Available from stock in the following assortments:
- 79023** – Value blister of 50 assorted red/black
- 79030** – Canister of 200 assorted red/black
- 40061** – Bulk pack of 1,000 black only
- 79079** – Finger grip black - 50 up



SIGMA™ SOFT TIPS

- 79026** – Sigma Spare Tips (clear) 50 up



MIRAGE CONTOUR SOFT TIPS

- › Transparent moulded soft tip
- › Available in blister pack of 50 pcs



79181 Contour Long - Clear Purple SML



79182 Contour Long - Clear SML



79183 Contour Long - Clear Black SML



79184 Contour Long - Clear Rosso SML



79185 Contour Long - Clear Blue SML

SPARE SOFT TIPS

TO SPECIAL ORDER ONLY, SPARE TIPS ARE ALSO AVAILABLE IN BAGS OF 1,000 AS FOLLOWS:



CONTOUR LONG SMALL

- *40020 Contour Tips - Long White SML
- *40021 Contour Tips - Long Black SML
- 40022 Contour Tips - Long Neon Yellow SML
- 40024 Contour Tips - Long Blue SML
- 40025 Contour Tips - Long Red SML
- 40027 Contour Tips - Long Neon Pink SML

* These 2 items now to be held in stock in Notts



CHECKOUT SMALL

- 40061 Checkout Tips - Black SML



CHECKOUT FINGER GRIP

- 40260 Checkout Tips - Finger Grip White
- 40261 Checkout Tips - Finger Grip Black



TEKNIK SMALL

- 40040 Teknik Tips - White SML
- 40041 Teknik Tips - Black SML
- 40042 Teknik Tips - Neon Yellow SML
- 40044 Teknik Tips - Blue SML
- 40045 Teknik Tips - Red SML

ACCESSORIES

IMPORTANT REPEAT SALES

MAESTRO®

DARTS TUNE-UP KIT

- › Contains Checkout Card, 8 sets of flights, 6 SlikStik shafts, 9 Gripper shafts, 6 XL shafts, 48 Ozones locking rings, 48 flight protectors and Jiffy dart sharpener

46111 3 kits per master carton



FLIGHTMATE

- › Neatly stores new or used flights
- › Protects them against damage
- › Holds up to 12 flights

76120 12 FlightMates per pack

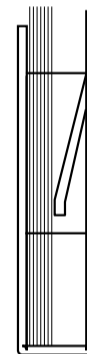

FLIGHT PROTECTORS

- › Clips over the top of the dart flight
- › Protects flights from damage by following darts

78222 Clear
78225 Black
8 protectors per card
12 per pack



PRO FLIGHT PROTECTORS

- › Lightweight aluminium
- › Clips over the top of the dart flight
- › Protects flights from damage from following darts

78223 Natural
78226 Black
12 sets per pack



KEYRING

- › Jiffy dart sharpener in handy rubberised keyring

76005 Blister packed 12 per pack



JIFFY®

DART SHARPENER

- › The original abrasive sharpening stone
- › Best quality vitrified silicon carbide
- › Double ended for twice the life

76002 Blister packed 12 per pack



CHECKOUT® POCKET CARD

- › Best ways to finish. Double sided

77000
Size 2 1/4" x 4 1/8" approx.
(57mm x 105mm)



GOLDEN MATCH®

- › The smallest darts in the world
- › Pure 24 carat gold plated barrels

75500 12 sets per pack

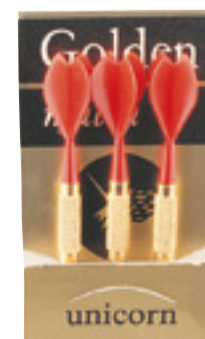

WALLETS & CASES

VERSATILE • STYLISH • TOTAL PROTECTION

MAXI WALLET

- › Compact size disguises huge and versatile storage capacity
- › Convenient 3 sided zip fastening allows fold flat opening for easy access
- › 14 accessory pockets for spare shafts, flights and sundries
- › Velcro fastening inner pouch
- › Elasticated dart carrier
- › Holds a set of darts fully loaded
- › Velcro belt loop



AUTOGRAPH COLLECTION

- 46125** Pink
- 46128** Autograph
- 46126** Fuchsia
- 3 cases per master carton
- Darts and accessories not included

NEW

- 46049** Unicorn
- 46156** Raymond van Barneveld
- 46176** Gary Anderson
- 3 cases per master carton

MIDI WALLET

- › Compact version of the best selling Maxi Case
- › Versatile and secure storage
- › Holds darts fully loaded
- › Specially designed compartments for flights and a full range of accessories

- 46090** 3 cases per master carton
- Darts and accessories not included



MAESTRO® WALLET

- › Big capacity folding wallet with velcro closure
- › Contains 16 flight protectors, 2 sets of XL aluminium shafts, 1 set of XL shafts, Jiffy dart sharpener and 3 sets of flights
- › Complete with unique removable Unicorn pocket Dart Caddy

- 46098** 3 cases per master carton



CONTENDER XL HARD CASE

- › Total protection for your darts
- › Holds a set of darts fully loaded
- › Comprehensive storage for a complete range of spares and accessories
- › Special compartments for flights, shafts, tips and accessories
- › Detachable zipped pocket for spares
- › Detachable Unicorn pocket dart caddy

- 46139** 3 cases per master carton



CONTENDER HARD CASE

- › Total protection for your darts
- › Holds a set of darts fully loaded
- › Lots of storage for spares and accessories
- › Detachable zipped pocket for spares
- › Detachable Unicorn pocket dart caddy

- 46140** 3 cases per master carton



3D WALLET

- › Tardis like capacity in 3 zipped compartments
- › Integral fittings to store darts, flights and shafts
- › Padded sections offer great protection
- › 3 sided zipped openings for easy access

- 46114** 3 cases per master carton



FAJITA WALLET

- › It's hot! It's a wrap!
- › Convenient, compact and secure
- › Holds one set of darts
- › Compartments for flights shafts and accessories

- 46138** 3 cases per master carton



POCKET DART FOB

- › Convenient compact size
- › 3 compartments
- › 1 external flight/accessory compartment

- 46143** 6 fobs per master carton



WOODEN DART CASE

- › Made from selected hardwoods
- › Traditional crushproof design
- › Holds darts with flights assembled
- › Polyurethane finish

- 46040** 6 cases per master carton



WALLETS & CASES

VERSATILE • STYLISH • TOTAL PROTECTION

PRO MAXI WALLET

- › Compact size disguises huge and versatile storage capacity
 - › Convenient 3 sided zip fastening allows fold flat opening for easy access
 - › 14 accessory pockets for spare shafts, flights and sundries
 - › Velcro fastening inner pouch
 - › Elasticated dart carrier
 - › Holds a set of darts fully loaded
 - › Aluminium carabiner belt hook
- 46205** 3 wallets per master carton



PRO MIDI WALLET

- › Compact version of the best selling Maxi Case
 - › Versatile and secure storage
 - › Holds darts fully loaded
 - › Specially designed compartments for flights and a full range of accessories
 - › Aluminium carabiner belt hook
- 46206** 3 wallets per master carton



DARTSAK WALLET

- › Back by popular demand!
 - › Holds 2 sets of darts plus flights and shafts
 - › Lightweight durable nylon
 - › Velcro closure
- 46207** 3 wallets per master carton



SHIRTS

COMFORT & FREEDOM OF MOVEMENT

TEAM DART SHIRT

- › Breathable Polyester Material
 - › 3 Button Placket
 - › Ribbed Collar
 - › Contrast Stitching Detail
 - › Insert Pocket to Left Chest
 - › Unicorn Logo to Right Chest
 - › Colours - Blue, Red & White
- (see men's size chart below for measurements)



COLOURS	BLUE	RED	WHITE
Small	803BS	803RS	803WS
Medium	803BM	803RM	803WM
Large	803BL	803RL	803WL
X Large	803BXL	803RXL	803WXL
XX Large	803BXXL	803RXXL	803WXXL
XXX Large	803BXXXL	803RXXXL	803WXXXL
XXXX Large	803BXXXXL	803RXXXXL	803WXXXXL
Small Boys	803JBS	TO FIT CHEST - 33"	
Medium Boys	803JBM	TO FIT CHEST - 35"	
Large Boys	803JBL	TO FIT CHEST - 37"	

PRO DART SHIRT

- › Micro Tuk 3 Lightweight Breathable Polyester Material
 - › Mesh to the Neck and Underarms for Cooling and Comfort
 - › Zip Collar
 - › Sublimated Gradient Print
 - › Contrast Stitching Detail
 - › Ribbed Collar
 - › Unicorn Logo to Right Chest
 - › Colours - Blue, Red & White
- (see men's size chart below for measurements)



COLOURS	BLACK/RED/RED	NAVY/BLUE/RED
Small	804BRS	804NBS
Medium	804BRM	804NBM
Large	804BRL	804NBL
X Large	804BRXL	804NBXL
XX Large	804BRXXL	804NBXXL
XXX Large	804BRXXXL	804NBXXXL
XXXX Large	804BRXXXXL	804NBXXXXL

MENS SIZE	SMALL	MEDIUM	LARGE	XLARGE	XXLARGE	XXXLARGE	XXXXLARGE
TO FIT CHEST	36" - 38"	39" - 41"	41" - 43"	43" - 46"	47" - 50"	50" - 53"	53" - 56"



85061
Sew-on Unicorn badge

POSTERS

POSTER SIZE 59.5cm x 42cm PORTRAIT or 42cm x 59.5cm LANDSCAPE

PLAYER STATISTICS

- 86671 Bob Anderson
- 86674 Gary Anderson
- 86519 John Lowe
- 86516 Raymond van Barneveld



NEW

NEW

TEAM UNICORN

86675 Team Unicorn



NEW

WAYS TO FINISH

86673 World Champion Ways To Finish

Player	Score	1st	2nd	3rd	4th	5th	6th	7th	8th	9th	10th	11th	12th	13th	14th	15th	16th	17th	18th	19th	20th	
BOB ANDERSON	100	T20	D18	D18	D18	D18	D18	D18	D18	D18	D18	D18	D18	D18	D18	D18	D18	D18	D18	D18	D18	
	100	T20	D18	D18	D18	D18	D18	D18	D18	D18	D18	D18	D18	D18	D18	D18	D18	D18	D18	D18	D18	
	99	T19	D18	D18	D18	D18	D18	D18	D18	D18	D18	D18	D18	D18	D18	D18	D18	D18	D18	D18	D18	
	98	T19	D18	D18	D18	D18	D18	D18	D18	D18	D18	D18	D18	D18	D18	D18	D18	D18	D18	D18	D18	
	97	T19	D18	D18	D18	D18	D18	D18	D18	D18	D18	D18	D18	D18	D18	D18	D18	D18	D18	D18	D18	
	96	T19	D18	D18	D18	D18	D18	D18	D18	D18	D18	D18	D18	D18	D18	D18	D18	D18	D18	D18	D18	D18
	95	T19	D18	D18	D18	D18	D18	D18	D18	D18	D18	D18	D18	D18	D18	D18	D18	D18	D18	D18	D18	D18
	94	T19	D18	D18	D18	D18	D18	D18	D18	D18	D18	D18	D18	D18	D18	D18	D18	D18	D18	D18	D18	D18
	93	T19	D18	D18	D18	D18	D18	D18	D18	D18	D18	D18	D18	D18	D18	D18	D18	D18	D18	D18	D18	D18
	92	T19	D18	D18	D18	D18	D18	D18	D18	D18	D18	D18	D18	D18	D18	D18	D18	D18	D18	D18	D18	D18
	91	T19	D18	D18	D18	D18	D18	D18	D18	D18	D18	D18	D18	D18	D18	D18	D18	D18	D18	D18	D18	D18
	90	T20	D18	D18	D18	D18	D18	D18	D18	D18	D18	D18	D18	D18	D18	D18	D18	D18	D18	D18	D18	D18
	89	T19	D18	D18	D18	D18	D18	D18	D18	D18	D18	D18	D18	D18	D18	D18	D18	D18	D18	D18	D18	D18
	88	T20	D18	D18	D18	D18	D18	D18	D18	D18	D18	D18	D18	D18	D18	D18	D18	D18	D18	D18	D18	D18
	87	T19	D18	D18	D18	D18	D18	D18	D18	D18	D18	D18	D18	D18	D18	D18	D18	D18	D18	D18	D18	D18
	86	T20	D18	D18	D18	D18	D18	D18	D18	D18	D18	D18	D18	D18	D18	D18	D18	D18	D18	D18	D18	D18
	85	T19	D18	D18	D18	D18	D18	D18	D18	D18	D18	D18	D18	D18	D18	D18	D18	D18	D18	D18	D18	D18
	84	T20	D18	D18	D18	D18	D18	D18	D18	D18	D18	D18	D18	D18	D18	D18	D18	D18	D18	D18	D18	D18
	83	T19	D18	D18	D18	D18	D18	D18	D18	D18	D18	D18	D18	D18	D18	D18	D18	D18	D18	D18	D18	D18
	82	T20	D18	D18	D18	D18	D18	D18	D18	D18	D18	D18	D18	D18	D18	D18	D18	D18	D18	D18	D18	D18
81	T19	D18	D18	D18	D18	D18	D18	D18	D18	D18	D18	D18	D18	D18	D18	D18	D18	D18	D18	D18	D18	
80	T20	D18	D18	D18	D18	D18	D18	D18	D18	D18	D18	D18	D18	D18	D18	D18	D18	D18	D18	D18	D18	
79	T19	D18	D18	D18	D18	D18	D18	D18	D18	D18	D18	D18	D18	D18	D18	D18	D18	D18	D18	D18	D18	
78	T20	D18	D18	D18	D18	D18	D18	D18	D18	D18	D18	D18	D18	D18	D18	D18	D18	D18	D18	D18	D18	
77	T19	D18	D18	D18	D18	D18	D18	D18	D18	D18	D18	D18	D18	D18	D18	D18	D18	D18	D18	D18	D18	
76	T20	D18	D18	D18	D18	D18	D18	D18	D18	D18	D18	D18	D18	D18	D18	D18	D18	D18	D18	D18	D18	
75	T19	D18	D18	D18	D18	D18	D18	D18	D18	D18	D18	D18	D18	D18	D18	D18	D18	D18	D18	D18	D18	
74	T20	D18	D18	D18	D18	D18	D18	D18	D18	D18	D18	D18	D18	D18	D18	D18	D18	D18	D18	D18	D18	
73	T19	D18	D18	D18	D18	D18	D18	D18	D18	D18	D18	D18	D18	D18	D18	D18	D18	D18	D18	D18	D18	
72	T20	D18	D18	D18	D18	D18	D18	D18	D18	D18	D18	D18	D18	D18	D18	D18	D18	D18	D18	D18	D18	
71	T19	D18	D18	D18	D18	D18	D18	D18	D18	D18	D18	D18	D18	D18	D18	D18	D18	D18	D18	D18	D18	
70	T20	D18	D18	D18	D18	D18	D18	D18	D18	D18	D18	D18	D18	D18	D18	D18	D18	D18	D18	D18	D18	
69	T19	D18	D18	D18	D18	D18	D18	D18	D18	D18	D18	D18	D18	D18	D18	D18	D18	D18	D18	D18	D18	
68	T20	D18	D18	D18	D18	D18	D18	D18	D18	D18	D18	D18	D18	D18	D18	D18	D18	D18	D18	D18	D18	
67	T19	D18	D18	D18	D18	D18	D18	D18	D18	D18	D18	D18	D18	D18	D18	D18	D18	D18	D18	D18	D18	
66	T20	D18	D18	D18	D18	D18	D18	D18	D18	D18	D18	D18	D18	D18	D18	D18	D18	D18	D18	D18	D18	
65	T19	D18	D18	D18	D18	D18	D18	D18	D18	D18	D18	D18	D18	D18	D18	D18	D18	D18	D18	D18	D18	
64	T20	D18	D18	D18	D18	D18	D18	D18	D18	D18	D18	D18	D18	D18	D18	D18	D18	D18	D18	D18	D18	
63	T19	D18	D18	D18	D18	D18	D18	D18	D18	D18	D18	D18	D18	D18	D18	D18	D18	D18	D18	D18	D18	
62	T20	D18	D18	D18	D18	D18	D18	D18	D18	D18	D18	D18	D18	D18	D18	D18	D18	D18	D18	D18	D18	
61	T19	D18	D18	D18	D18	D18	D18	D18	D18	D18	D18	D18	D18	D18	D18	D18	D18	D18	D18	D18	D18	
60	T20	D18	D18	D18	D18	D18	D18	D18	D18	D18	D18	D18	D18	D18	D18	D18	D18	D18	D18	D18	D18	
59	T19	D18	D18	D18	D18	D18	D18	D18	D18	D18	D18	D18	D18	D18	D18	D18	D18	D18	D18	D18	D18	
58	T20	D18	D18	D18	D18	D18	D18	D18	D18	D18	D18	D18	D18	D18	D18	D18	D18	D18	D18	D18	D18	
57	T19	D18	D18	D18	D18	D18	D18	D18	D18	D18	D18	D18	D18	D18	D18	D18	D18	D18	D18	D18	D18	
56	T20	D18	D18	D18	D18	D18	D18	D18	D18	D18	D18	D18	D18	D18	D18	D18	D18	D18	D18	D18	D18	
55	T19	D18	D18	D18	D18	D18	D18	D18	D18	D18	D18	D18	D18	D18	D18	D18	D18	D18	D18	D18	D18	
54	T20	D18	D18	D18	D18	D18	D18	D18	D18	D18	D18	D18	D18	D18	D18	D18	D18	D18	D18	D18	D18	
53	T19	D18	D18	D18	D18	D18	D18	D18	D18	D18	D18	D18	D18	D18	D18	D18	D18	D18	D18	D18	D18	
52	T20	D18	D18	D18	D18	D18	D18	D18	D18	D18	D18	D18	D18	D18	D18	D18	D18	D18	D18	D18	D18	
51	T19	D18	D18	D18	D18	D18	D18	D18	D18	D18	D18	D18	D18	D18	D18	D18	D18	D18	D18	D18	D18	

STICKERS / BADGES



86018 Window/Shelf Sticker 8cm x 30cm



85156 Self Adhesive Unicorn badge 2cm x 6cm



85061 Sew-on Unicorn badge



86405

FRED 2 Floor Standing Display Unit

- › Specifically designed to maximise the display capacity for Unicorn's 4 Dart pack formats in the 2013 range
- › Fully adjustable, it will still hold a comprehensive range of darts and accessories in all Unicorn packaging formats
- › In standard format it is supplied with provision for 3 rows of darts and 2 rows of accessories
- › Lockable dart display bars available to order
- › Additional standard and accessory bars available to order
- › Base has capacity for 8 dartboards
- › De-mountable promotional side display panels will be available on a periodic basis
- › Width at base 750mm Height 2000mm Depth at base 653mm (Side wing graphics plus 280mm x2)

86404

FRED 2 Wall Mounted /Counter Display Unit

- › Specifically designed to maximise the display capacity for Unicorn's 4 Dart pack formats in the 2013 range
- › Fully adjustable, it will still hold a comprehensive range of darts and accessories in all Unicorn packaging formats
- › In standard format it is supplied with provision for 2 rows of darts and 2 rows of accessories
- › Lockable dart display bars available to order
- › Additional standard and accessory bars available to order
- › Spot Light kits available to order
- › Free standing for counter display or can be wall hung
- › De-mountable promotional side display panels will be available on a periodic basis
- › Width 600mm Height 1000mm Depth 302mm (Side wings graphics plus 261mm x2)

86410

Security bar - fits any row
(86405 and 86404 only)

86412

Accessory display bar
(86405 and 86404 only)



86420

FRED 2 Slimline Floor Standing Display Unit.

- › All the features of 86405 but in a slimline unit.
- › Supplied with provision for 4 rows of darts and 2 rows of accessories.
- › Base has capacity for 7 dartboards
- › Width at base 496mm Height 2000mm Depth at base 532mm

86423

Accessory display bar - slim
(86420 only)

85116

FRED Slat Wall Header



Universal FRED 2 Display Unit Items

86411

Standard hook

86421

Hook stop releaser

86422

Pack of 10 hook stops

CROSS-PLAYER RANGES AT A GLANCE

STEEL TIP

SOFT TIP

SILVER STAR™ 80% TUNGSTEN

SILVER STAR™ 80% TUNGSTEN



RAYMOND van BARNEVELD

07416 22g 07417 24g 07418 26g
07419 28g



RAYMOND van BARNEVELD

02827 17g 02828 19g



GARY ANDERSON

08558 21g 08559 23g 08560 25g
08561 27g

NEW



GARY ANDERSON

23208 17g 23209 19g



JAMES WADE

08563 22g 08564 24g 08565 26g
08566 28g



NEW KIM HUYBRECHTS

27315 21g 27316 23g 27317 25g
27318 27g



NEW MICHAEL SMITH

27308 22g 27309 24g 27310 26g
27311 28g 27312 30g

NEW



MICHAEL SMITH

23204 18g 23205 20g

BLACK STAR™ 80% TUNGSTEN

BLACK STAR™ 80% TUNGSTEN



RAYMOND van BARNEVELD

07196 24g 07197 26g



RAYMOND van BARNEVELD

04140 17g



NEW GARY ANDERSON

27418 21g 27419 23g 27420 25g

NEW



GARY ANDERSON

23216 17g

BULLET® STAINLESS STEEL

BULLET® STAINLESS STEEL



RAYMOND van BARNEVELD

07547 21g 07548 23g 07549 25g



RAYMOND van BARNEVELD

02835 17g 02836 19g



NEW GARY ANDERSON

27326 22g 27327 24g 27328 26g

NEW



GARY ANDERSON

23213 16g 23214 18g



JOHN LOWE

07291 21g 07292 23g 07293 25g



JOHN LOWE

03222 20g

BLACK BRASS

BLACK BRASS



RAYMOND van BARNEVELD

07715 22g 07716 24g 07717 26g



RAYMOND van BARNEVELD

04080 17g 04081 19g



NEW GARY ANDERSON

27331 23g 27332 25g 27333 27g

NEW



GARY ANDERSON

23193 16g 23194 18g

TO OUR CUSTOMERS....

Our aim is to make trading with Unicorn easy.

We try very hard to have an appreciation of our customers' problems and to have a minimum of rules.

We feel the stating of our policies will make it easier and more profitable for our customers to deal with Unicorn.

1. WARNING

DARTS IS AN ADULT SPORT. IT IS DANGEROUS FOR CHILDREN TO PLAY WITHOUT SUPERVISION. WE RECOMMEND THAT A DEALER SHOULD EXERCISE DISCRETION WHERE ANY SALE MIGHT RESULT IN CHILDREN PLAYING WITHOUT ADULT SUPERVISION.

2. DISTRIBUTION

We are geared to supply goods to accredited retailers only and thus cannot give satisfaction to clubs or individuals, whom we refer to local dealers, anxious and ready to provide a prompt and complete service.

3. SPECIFICATIONS

We have taken every care to ensure that the information detailed in this catalogue is truthful and accurate. All weights and sizes are approximate and for guidance and comparison only. Should circumstances arising subsequent to publication render as unavoidable some changes in production, Unicorn Products Limited reserves absolute discretion to make these or any other changes they deem necessary without notice or obligation.

4. PRODUCT IMPROVEMENT

Continuous research and development will bring about changes in design, material and arrangement of our products during the life of this catalogue. We shall pass to our customers such benefits or improvements as they occur by delivering the latest version of any product. Such improvements or modifications as may be introduced do not place us under any obligation to make similar changes in articles sold before the date of introduction.

5. STANDARD PACKS

Many of the items in this catalogue are prepacked in convenient size standard packs. The standard pack has been selected for ease of stocking and ordering, economy in production and to ensure safe transit of the contents. For these reasons we cannot split standard packs and where orders call for other than standard packs we shall adjust the order to the nearest pack quantity.

6. GUARANTEE

It is our aim to ensure the complete satisfaction of our customers and in case of a genuine complaint as to the quality of our goods, we shall be anxious to rectify any fault of our own free will and at our discretion only.

7. IMITATIONS

The design, construction and trade names of most of our products are protected by patents, design registrations, trade marks, copyrights and/or pending applications and rigorous action will be taken against all infringers to protect both dealer and users from imitation.

8. ACCEPTANCE OF ORDER

All orders are accepted by us on the understanding that our Conditions of Sale as stated in our current price list form the basis of the Contract of Sale entered into by the placing and acceptance of such orders.

Unicorn Products Limited

Telephone: 0115 985 3500

Fax: 0115 985 3501

Email: assist@unicorngroup.com

Web: www.unicorn-darts.com

All returned goods must be sent to
GM Operations Centre
Trent Lane, Colwick,
Nottingham NG2 4DS

© 2015 Unicorn Products Limited

The entire contents of this publication are the copyright of Unicorn Products Limited and may not be reprinted, copied or otherwise duplicated without written consent of the copyright owners

Catalogue designed by TGV, London
24157000 #85012

REFERENCE LINKS :

- 1 Unicorn Darts main website
<http://www.unicorn-darts.com/>



- 2 Unicorn - Heritage
<http://www.unicorn-darts.com/community/heritage/>



- 3 Team Unicorn
<http://www.unicorn-darts.com/team/>



- 4 UniLab
<http://www.unicorn-darts.com/unilab/>



- 5 UniScore
<http://uniscore.unicorn-darts.com/>



"There is hardly anything in the world that some man cannot make a little worse and sell a little cheaper, and the people who consider price only are this man's lawful prey."

John Ruskin